

Camcruiser®

Models CVC72, CVC724



Features & Benefits

- Load this foodservice merchandising cart with pizza, sandwiches, hot dogs, salads, tacos, chips, and soft drinks. Transports easily for added sales and increased convenience.
- Double-wall, high-density, polyethylene construction is impact resistant and will not dent, crack, bubble, chip or break. Can be wiped or steam cleaned.
- Two polyurethane foam-insulated holding compartments keep food hot or cold for hours. Doors swing open 270° for easy and complete access.
- GN 1/1 Full Size Food Pans capacity per compartment:
 - 4 each, 6" (15 cm) deep
 - 6 each, 4" (10 cm) deep
 - or 8 each, 2½" (6,5 cm) deep.
- Model CVC72 has 3 each top serving wells. The 2 outside wells are for merchandising only and do not hold food pans. The dimensions are 22" x 15" x 6" (56 x 38 x 15 cm). The center well holds 1 each GN Full, Half or Third Size Food Pans, 6" (15 cm) deep, without the use of Divider Bars. It will not accommodate a cutting board or well cover.
- Model CVC724 has 4 each top serving wells. Each well holds 1 each GN Full Size Food Pan or Fractional Food Pans, 6" (15 cm) deep, with DIV12 Divider Bars. Also holds one white polyethylene Cutting Board (included) or optional molded Well Cover to increase work preparation area.
- Open middle holding compartment on the bottom serving side of both models holds one cash drawer with cash box (included). Also holds GN 1/1 Full Size Food Pans:
 - 1 each 6" (15 cm) deep
 - 2 each 4" (10 cm) deep
 - or 3 each 2½" (6,5 cm) deep.
- Menu board included and helps merchandise daily menu or daily specials.
- Removable 6' (183 cm) umbrella comes in a variety of colors and can be customized. Campus Cuisine front cart panel is standard and print color matches the color of the cart. Display panel can also be personalized as an option.
- Molded-in handles on both sides provided comfortable easy transporting.
- Four each 8" (20,3 cm) swivel casters w/ brakes ensure easy maneuvering.
- Non-electrical.
- Some assembly required.
- Available in 6 colors.

Item No. _____

Specifier Identification No. _____

Model No. _____

Quantity _____



CVC724



CVC72



Open holding compartment holds cash drawer and box. (included)



Two insulated holding compartments each hold up to 4 each GN 1/1 Full Size 6" (15 cm) deep Food Pans.

Camcruiser®

Models CVC72, CVC724

Item No. _____

Specifier Identification No. _____

Model No. _____

Quantity _____

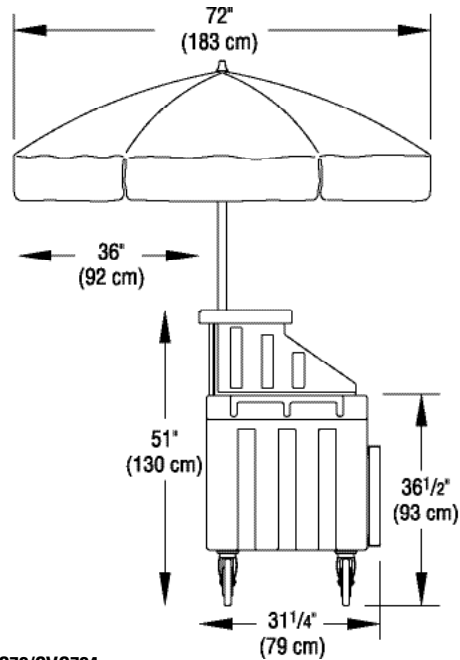
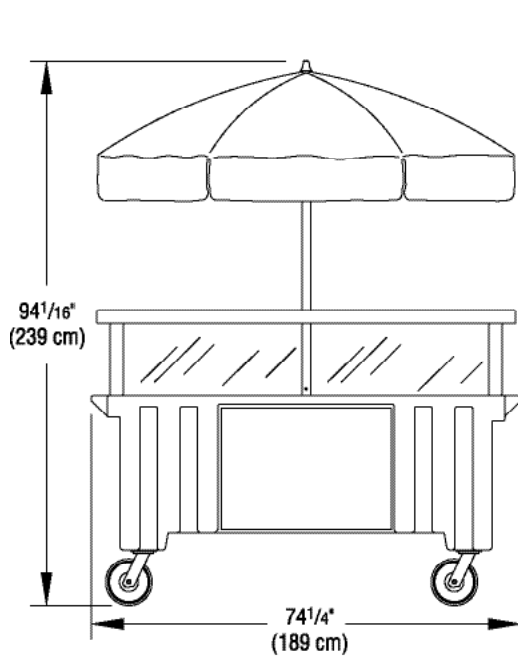

CVC72/CVC724

Specifications

Dimension Tolerance: +/- 1/8" (0,64 cm)

Code	Description	Overall Dimensions L x W x H (With Umbrella)	Case lbs./cube Kg/m ³
CVC72	Camcruiser with 1 GN Full Size Food Pan and 2 Food Merchandising Wells.	74 1/4" x 72" x 94 1/16" (189 x 183 x 239 cm)	240 (75,47) 109 (2)
CVC724	Camcruiser with 4 GN Full Size Food Pan Wells	74 1/4" x 72" x 94 1/16" (189 x 183 x 239 cm)	240 (75,47) 109 (2)

Optional Accessories (CVC724 Only)

- Divider Bar** DIV12 White (148)
- Additional Cutting Board** CB1220 White (148)
- Retainer Strap** 730STP
- Well Cover** WCR1220

Standard Colors

- Camcruiser:**
- Granite Gray (191) w/ Gray Umbrella
 - Granite Green (192) w/ Green Umbrella
 - Black (110) w/ Black/White Umbrella
 - Red (158) w/ Red/White Umbrella
 - Blue (187) w/ Blue/White Umbrella
 - Green (519) w/ Green/White Umbrella

Architect Specs

The portable foodservice cart shall be a Camcruiser, Model CVC72 or CVC724, manufactured by Cambro Mfg. Co., Huntington Beach, CA 92648 U.S.A. It shall be made of polyethylene and foam-injected polyurethane. It shall have molded-in handles on both sides for easy maneuvering. It shall have 4 each 8" (15 cm) swivel casters, w/ brakes. It shall have 3 or 4 top service wells. Each insulated food pan well shall hold a full size 12" x 20" (32,5 x 53 cm) Food Pan, 6" (15 cm) deep or Fractional Size Food Pans with Divider Bars. Each food merchandising well shall be 22" x 15" x 6" (54 x 33,5 x 15 cm). It shall have 2 insulated lower compartments with swinging doors that open 270° to side wall. Each compartment shall hold up to 4 each GN 1/1 full size 6" (15 cm) food pans. It shall have a 6 ft. (183 cm), six panel umbrella. It shall have a large front merchandising panel with a standard Campus Cuisine logo. It shall include a FDA approved polyethylene cutting board and shall be available with the optional color matching well covers. It shall have a white erasable menu board and cash drawer and cash box. It shall be offered in 6 colors.

Well Cover:

- Black (110)
- Red (158)
- Blue (187)
- Green (519)
- Granite Gray (191)
- Granite Green (192)