



Project _____

Item # _____

Quantity _____

Built-In Full-Size Uninsulated Heated Wells

Models: HWBL-FUL, -FULD, -FULDA
HWB-FUL, -FULD, -FULDA
HWBH-FUL, -FULD, -FULDA

Hatco Built-In Rectangular Heated Wells provide flexibility and quality, with many options to choose from. These units hold steam table food hot and fresh with thermostats that read the actual temperatures and add heat only when needed.

Standard features

- Rectangular Full-Size Uninsulated Heated Well in top or bottom mount
- Superior thermostat controls that read the actual temperature of the well and add heat only if needed
- Controls feature a separate lighted ON/OFF rocker switch and temperature dial, allowing preset temperatures to be maintained
- Low (120V only), Standard and High Watt available
- Available with or without a drain (50% larger drain with flat screen simplifies cleaning and holds pans level)
- EZ locking hardware for quick installation
- Thicker stainless steel construction and solid brazed joints for durability
- Easy service access to heating elements and thermostats

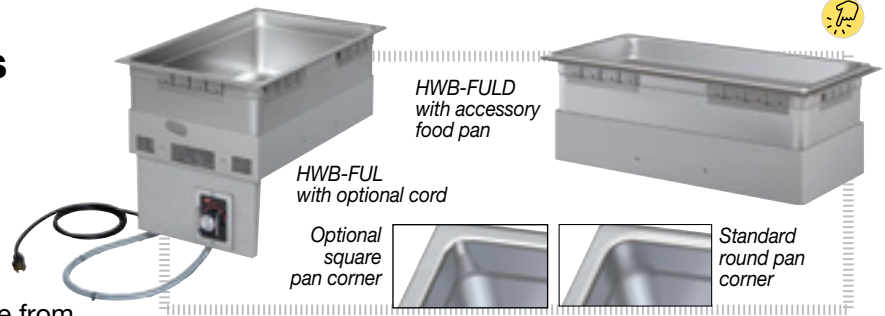

Options (available at time of purchase only)

- Additional High Temp Power Supply Lead Wire available in one foot (305 mm) increments (Lead wire only – the lead wire extensions beyond the standard 3' conduit whip) *Models are shipped standard with 1' [305 mm] of lead wire extensions*
- Flexible Conduit between the control and the Rectangular Heated Well
 - Standard Flexible Conduit, 36" (914 mm)
 - Flexible Conduit, 72" (1829 mm)
- HWB-FUL, -FULD with Optional Cord (In lieu of conduit and lead wire, not available for auto-fill and low watt models in 120V only)
- Control Box (Options not available for auto-fill):
 - Standard (Compact) Thermostat with 6' (1829 mm) Capillary (Standard 120V)
 - ITC Control with Large Control (Not available for low watt, auto-fill configurations or units without a drain)
 - Larger Recessed Thermostatic Control [Standard for 220/240V models (except units with cord and plug). Not available for units with autofill]
 - WM Control Assembly Replacement (Not available for auto-fill or export models)
- Control Box Bezel in *Designer Colors* (Option is not available for Auto-fill or HWB-FUL with Optional Cord, Nonstandard colors are non-returnable, Stainless Steel standard)
 - Warm Red Black Gray Granite White Granite
 - Navy Blue Hunter Green Antique Copper
- Left or Right Water Fill Hole for HWBL-, HWB-, HWBH-FULDA only (Front is standard)
 - Right Left
- Pan Corners (In lieu of standard round pan corners)
 - Square Pan Corners

Accessories

- Rectangular Full-Size Stainless Steel Food Pans:
 - Third-Size (2.5" [64 mm] H) Half-Size (2.5" [64 mm] H)
 - Full-Size (2.5" [64 mm] H) Full-Size (4" [101 mm] H)
 - Full-Size (6" [152 mm] H)
- Round Food Pans:
 - 4 Quart (4 Liter) 7 Quart (7 Liter)
- Hinged Lid for Round Pans:
 - 4 Quart (4 Liter) 7 Quart (7 Liter)
- Notched Lid for Round Pans:
 - 4 Quart (4 Liter) 7 Quart (7 Liter)
- Stainless Steel Wire Trivets:
 - Half-Size Full-Size
- Adapter to Convert Warmers to hold Round Pans:
 - Holds three 4-Quart (4-Liter) Inserts Holds two 7-Quart (7-Liter) Inserts
- Support Bars: 12" (305 mm) 20" (508 mm)
- Mounting Kit for: Combustible Countertops Thick Countertops
- 3/4" Ball Valve for Unit with Drains
- 3/4" Gate Valve for Unit with Drains
- Heated Well Remote Handle for 3/4" drains (Includes a Ball Valve)

■ IFS anti-microbial coatings use naturally-occurring, environmentally sustainable, silver ions to help inhibit the growth of microbes on the powder coated surface. See www.hatcocorp.com/antimicrobial-paint for more information.

For operation, location and safety information, please refer to the Installation and Operating Manual.



HATCO CORPORATION | P.O. Box 340500 Milwaukee, WI 53234-0500 U.S.A. | (414) 671-6350



www.hatcocorp.com | support@hatcocorp.com | [Find a Hatco Rep](#) | [Image Library](#) | [Document Library](#) | [Patents](#) | [Chat](#)



Built-In Full-Size Uninsulated Heated Wells

Models: HWBL-FUL, -FULD, -FULDA, HWB-FUL, -FULD, -FULDA, HWBH-FUL, -FULD, -FULDA

Ordering Instructions

(Please specify the following with each order)

- Desired Voltage:** 120, 208, 220 or 240V (export voltage available)
- Pan Corners**
 - Rounded (Standard)
 - Square
- Drain** (With or without)

- Auto-fill** (With or without)
 - Front location (Standard)
 - Left location
 - Right location
- Mounting Style**
 - Top Mounted
 - Bottom Mounted

- Wattage**
 - High Watt
 - Standard Watt
 - Low Watt (120V only)
- Agency:**
 - UL, C-UL
 - UL-EPH (Sanitary listing)
 - CE mark available

Uninsulated Top Mount Heated Wells — HWB-FUL, -FULD

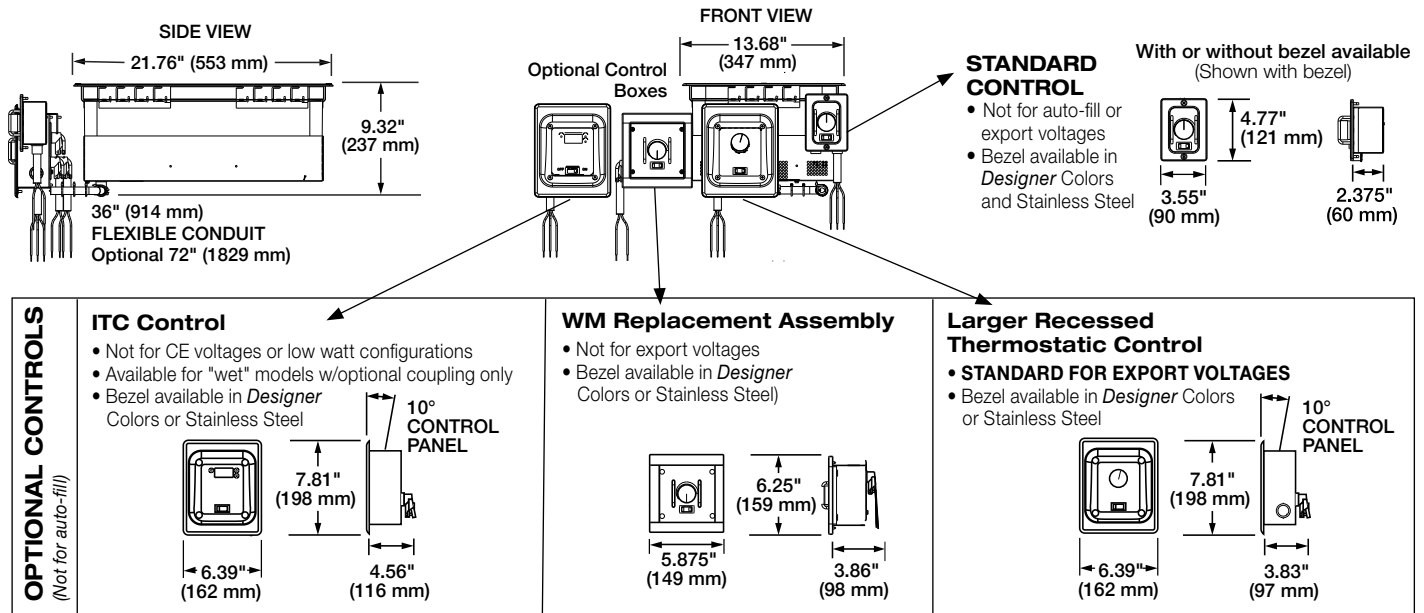

HWB-FUL, -FULD-Cord Series

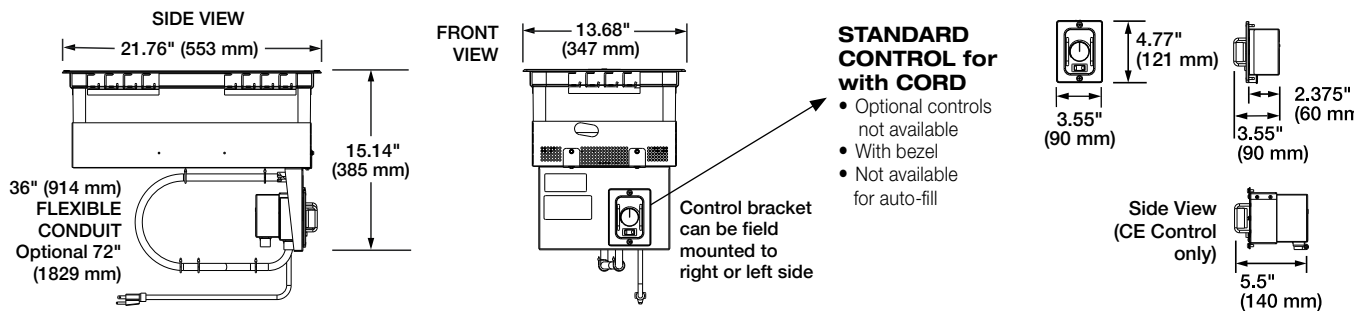

HWB-FULDA (Auto-fill)

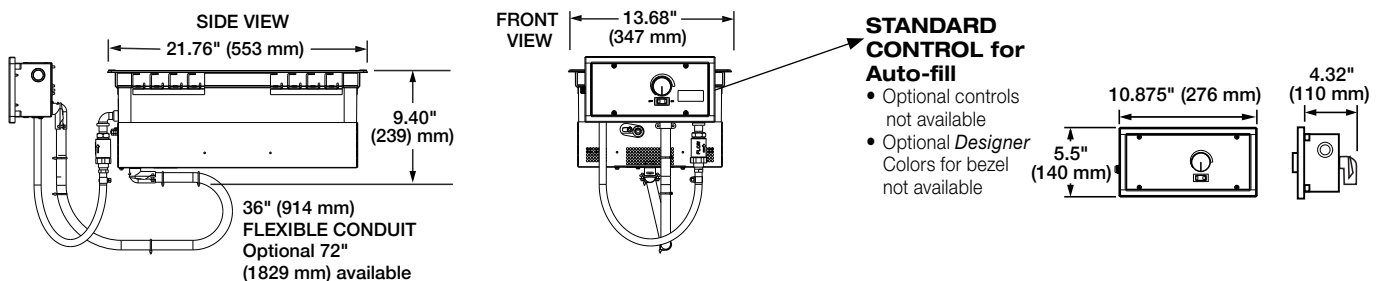

HATCO CORPORATION | P.O. Box 340500 Milwaukee, WI 53234-0500 U.S.A. | (414) 671-6350



www.hatcocorp.com | support@hatcocorp.com | [Find a Hatco Rep](#) | [Image Library](#) | [Document Library](#) | [Patents](#) | [Chat](#)



Built-In Full-Size Uninsulated Heated Wells

Models: HWBL-FUL, -FULD, -FULDA, HWB-FUL, -FULD, -FULDA, HWBH-FUL, -FULD, -FULDA

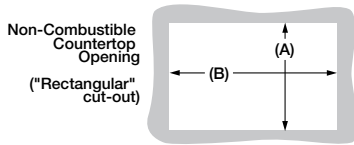

Cutout Dimensions for Non-Combustible Countertops

Model	Minimum Width (A)	Maximum Width (A)	Minimum Depth (B)	Maximum Depth (B)
HWB-FUL Series	12.625" (321 mm)	12.94" (328 mm)	20.625" (524 mm)	20.94" (531 mm)
HWB-FULDA Series	12.625" (321 mm)	12.94" (328 mm)	20.625" (524 mm)	20.94" (531 mm)

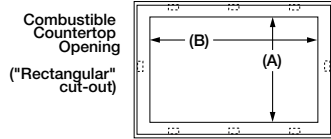

Cutout Dimensions for Combustible Countertops ▲

Model	Minimum Width (A)	Maximum Width (A)	Minimum Depth (B)	Maximum Depth (B)
HWB-FUL Series	14" (356 mm)	14.25" (362 mm)	22" (559 mm)	22.25" (565 mm)
HWB-FULDA Series	14" (356 mm)	14.25" (362 mm)	22" (559 mm)	22.25" (565 mm)

▲ Accessory Mounting Kit required for Top Mounts

Cutout Dimensions for Control Boxes

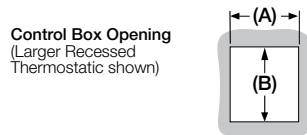

Control Box	Width (A)	Height (B)	International Models
Standard Thermostatic without bezel	2.16" (55 mm)	3.375" (86 mm)	Not available
Standard Thermostatic with bezel	3.25" (83 mm)	3.75" (95 mm)	Not available
Optional Larger Recessed Thermostatic	5.875" (149 mm)	6.375" (162 mm)	Standard
Optional ITC Electronic (not available for 4-QT [4-Liter]) or Low Watt	5.875" (149 mm)	6.375" (162 mm)	Optional
Optional WM Assembly Replacement	4.78" (121 mm)	5.00" (127 mm)	Not available
Standard Auto-fill	10.125" (257 mm)	4.75" (121 mm)	Standard

Full Size Uninsulated Rectangular Models

The shaded areas contain electrical information for International models only

	Model	Dimensions (Width x Depth x Height)	Volts (Single Phase)	Watts	Amps	Optional Plug Hardwired Standard	Control Configuration*		Approx. Ship Weight	
							Standard	Optional		
Low Watt	HWBL-FUL, HWBL-FULD (Top or Bottom Mount)	13.68" x 21.76" x 9.32" (347 x 553 x 237 mm)	120	750	6.3	NEMA 5-15P	Compact Thermostatic (with bezel)	WM or Larger Recessed Thermostatic Controls	22 lbs. (10 kg)	
		Optional HWB-Cord*: 13.68" x 21.76" x 15.14" (347 x 553 x 385 mm)								
	HWBL-FULDA (Top or Bottom Mount)	13.68" x 21.76" x 9.40" (347 x 553 x 239 mm)				Not Available	Auto-fill	None	21 lbs. (9 kg)	
Standard Watt	HWB-FUL HWB-FULD (Top or Bottom Mount)	13.68" x 21.76" x 9.32" (347 x 553 x 237 mm) Optional HWB-Cord*: 13.68" x 21.76" x 15.14" (347 x 553 x 385 mm)	120	1200	10.0	NEMA 5-15P	Compact Thermostatic (with bezel)	WM, Larger Recessed or ITC Electronic Controls* (*HWB-FULD only)	22 lbs. (10 kg)	
			208		5.8					NEMA 6-15P
			240		5.0					
			220	1200	5.5	CEE 7/7 SCHUKO, CCC	Larger Recessed Thermostatic	ITC Electronic Control (HWB-FULD and non-CE only)		
			220-230 (CE)							
			240						5.0	BS-1363 or AS 3112
230-240 (CE)	BS-1363									
HWB-FULDA (Top or Bottom Mount)		13.68" x 21.76" x 9.40" (347 x 553 x 239 mm)	120	1215	10.1	Not Available	Auto-fill	None	31 lbs. (14 kg)	
	208		5.8							
	240		5.1							
	220		1215	5.5	Not Available	Auto-fill	None			
	220-230 (CE)							1215/1328	5.5/5.8	
	240							1215	5.1	
230-240 (CE)	1116/1215	4.9/5.1								

* Only control for optional HWB-Cord is the Compact Thermostatic Control with bezel.

HATCO CORPORATION

P.O. Box 340500 Milwaukee, WI 53234-0500 U.S.A. | (414) 671-6350



www.hatcocorp.com

support@hatcocorp.com

[Find a Hatco Rep](#)

[Image Library](#)

[Document Library](#)

[Patents](#)

[Chat](#)



Built-In Full-Size Uninsulated Heated Wells

Models: HWBL-FUL, -FULD, -FULDA, HWB-FUL, -FULD, -FULDA, HWBH-FUL, -FULD, -FULDA

Full Size Uninsulated Rectangular Models

The shaded areas contain electrical information for International models only

	Model	Dimensions (Width x Depth x Height)	Volts (Single Phase)	Watts	Amps	Optional Plug Hardwired Standard	Control Configuration*		Approx. Ship Weight
							Standard	Optional	
High Watt	HWBH-FUL HWBH-FULD (Top or Bottom Mount)	13.68" x 21.77" x 9.32" (347 x 553 x 237 mm) Optional HWB-Cord*: 13.68" x 21.77" x 15.14" (347 x 553 x 385 mm)	120	1650	13.8	NEMA 5-20P	Compact Thermostatic (with bezel)	WM Assembly, Larger Recessed or ITC Electronic Control* (*HWBH-FULD only)	22 lbs. (10 kg)
			208		7.9	NEMA 6-15P			
			240		6.9				
			220	1650	7.5	CEE 7/7 SCHUKO	Larger Recessed Thermostatic	ITC Electronic Control (HWBH- FULD and non-CE only)	
			220-230 (CE)			CEE 7/7 SCHUKO, CCC			
			240		6.9	BS-1363 or AS 3112			
	230-240 (CE)	BS-1363							
	HWBH-FULDA (Top or Bottom Mount)	13.68" x 21.77" x 9.40" (347 x 553 x 239 mm)	120	1665	13.9	Not Available	Auto-fill	None	26 lbs. (12 kg)
			208		8.0				
			240		6.9				
			220	1665	7.6	Not Available	Auto-fill	None	
			220-230 (CE)	1665/1820	7.6/7.9				
240			1665	6.9					
230-240 (CE)	1529/1665	6.6/6.9							

* Only control for optional HWB-Cord is the Compact Thermostatic Control with bezel.

PLUG CONFIGURATIONS (Optional)

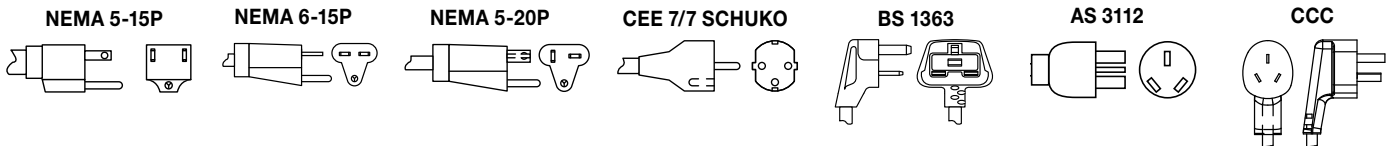

PRODUCT SPECS Built-In Rectangular Uninsulated Heated Wells

The Built-In Rectangular Uninsulated Heated Well with or without cord and plug or with rounded or square corners shall be a Modelas manufactured by the Hatco Corporation, Milwaukee, WI 53234 U.S.A.

Built-in Rectangular Uninsulated Heated Well shall be rated atwatts,volts, and be...inches (millimeters) in overall width and be ...inches (millimeters) in overall depth. It shall consist of stainless and aluminized steel housing with a metal sheathed heating element, EZ locking hardware for installation, and a remote thermostat with lighted power switch.

Options may include additional supply lead wires, conduits, cord in lieu of conduit and lead wire, control boxes, bezel in Designer colors (with the exception of Auto-Fill), left or right water fill hole and square pan corners in lieu of round pan corners.

Accessories may include stainless steel mounting kit, adapter bars, adapter top, support bars, food pans, remote handle and valves.

Warranty consists of 24/7 parts and service assistance (US and Canada only).

HATCO CORPORATION | P.O. Box 340500 Milwaukee, WI 53234-0500 U.S.A. | (414) 671-6350



www.hatcocorp.com | support@hatcocorp.com | [Find a Hatco Rep](#) | [Image Library](#) | [Document Library](#) | [Patents](#) | [Chat](#)