



A family company manufacturing in the USA

www.glastender.com

Project: _____	AIA# _____
Item #: _____ Qty: _____	SIS# _____
Model #: _____	

Mobile Freezers

FRM	FRM-2-C, FRM-2
------------	----------------

Standard Features

- All stainless steel exterior with 16 gauge galvanized steel exterior bottom.
- Completely integrated design - not just a cabinet with separate drop-in module
- All stainless steel interior liner with radius corners for easy cleaning
- One-piece, seamless top
- Includes four 4-1/8" casters, with two locking casters
- Eco friendly foamed-in-place insulation has zero impact on global warming or ozone depletion
- Eight foot grounded cord and plug provided, exits at rear
- Designed to accommodate outlet behind unit and still sit flush against the wall
- Mechanical thermostat with off setting
- FRM-2 holds (2) 3-gallon ice cream containers
- FRM-2-C holds craft cocktail ice

Configurable Options

- FRM-2-C Elevation Height



FRM-2-C

FRM-2



FRM-2-C
Elevation Height



Intertek
EP 5016978
Energy Performance
Verified / Rendement
Énergétique Vérifié



Intertek
4004503
Conforms to
NSF/ANSI STD 7
and UL STD 471
Certified to
CSA STD C22.2 No. 120



Intertek

Intended for indoor use.

Specifications

		FRM-2-C	FRM-2
Dimensions	Exterior	24"D x 14"W x 31-1/4"H Elevation - 24"D x 14"W x 37-1/4"H	18"D x 24"W x 36-3/8"H
	Interior Storage	19-7/8"D x 9-7/8"W x 11-1/4"H	10"D x 20"W x 12-1/4"H
Electrical	Electrical Supply	120V, 1 phase, 60 Hz, Dedicated 15A circuit required	
	Full Load Amps	3.5	
	Plug Type	8 foot NEMA 5-15P grounded cord and plug	
Refrigeration	Refrigerant	R290 100g (3.53 oz)	
	Compressor	1/4 HP, 0.06 Ton	
	Heat Rejection	1,433 BTU/hr heat rejection	
Operating Range		-5°F (-20°C) to 10°F (-12°C)	

Casters

- Four 4-1/8" heavy duty rubberized casters
- The two front side casters are locking

Materials

- Stainless steel parts include: all components unless otherwise noted
- Galvanized steel parts include: cabinet floor, condensing unit floor, and base channels



Glastender, Inc. • 5400 North Michigan Road • Saginaw, MI • 48604-9780 989.752.4275 • 800.748.0423 • Fax 989.752.4444 www.glastender.com	Approval/Notes:
Specifications subject to change without notice. For current specifications please visit our website.	

Mobile Freezers

Drawings

PLAN VIEW

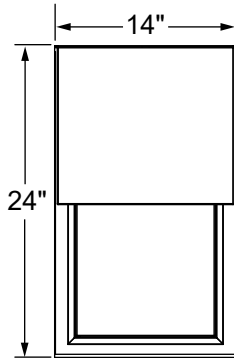

FRONT VIEW

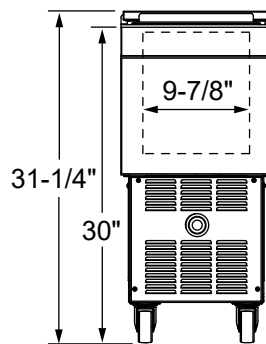

SIDE VIEW

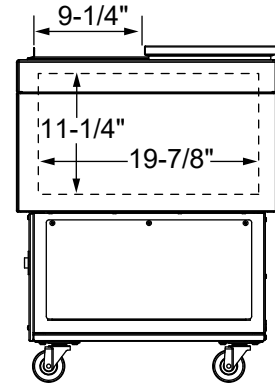

FRM-2-C

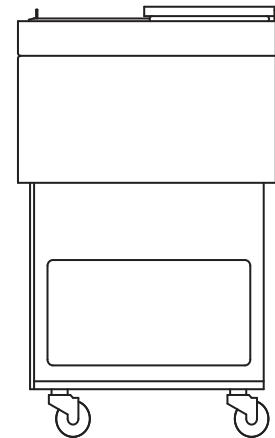
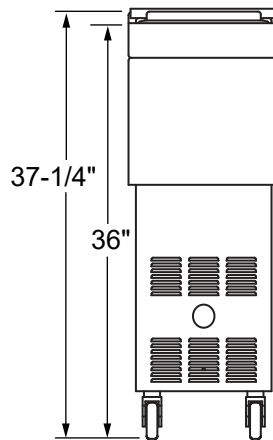

FRM-2-C - ELEVATION HEIGHT

PLAN VIEW

FRM-2

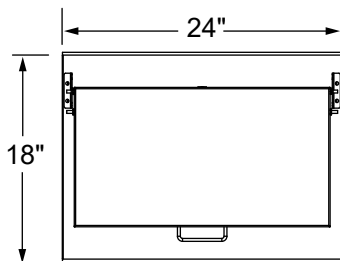

FRONT VIEW

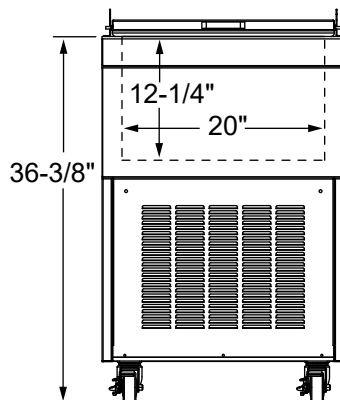

SIDE VIEW

