



RESOURCES

Threaded Stem Casters

3/4" - 13 x 1" Threaded Stem Casters With Gray Rubber Wheel

Certifications:



Features:

- Double Ball Bearing Raceway for Long Wear and Added Strength
- With or Without Top Lock Brake
- Raceway Dust Cover

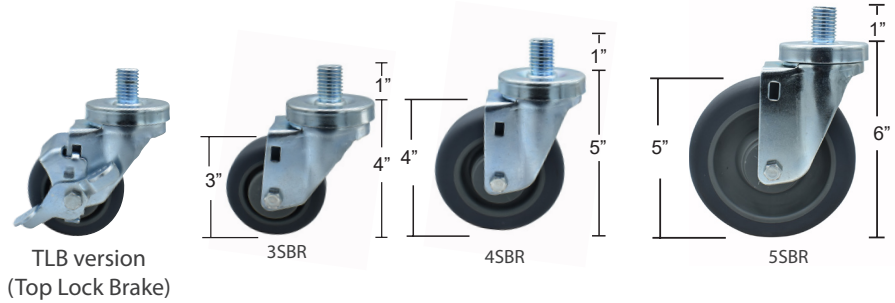

Material:

- Resistant to Oil, Grease, Water and Most Solvents
- Temperature Range -45° to 180°F
- Non-Marking
- Zinc Plated
- Gray Rubber Wheel

Part Number	Brake	Wheel Size	Capacity
3SBR-6ST-GR	-	3"	250 LBS
3SBR-6ST-GR-TLB	TLB	3"	250 LBS
4SBR-6ST-GR	-	4"	250 LBS
4SBR-6ST-GR-TLB	TLB	4"	250 LBS
5SBR-6ST-GR	-	5"	250 LBS
5SBR-6ST-GR-TLB	TLB	5"	250 LBS

PRODUCT DATA SHEET

RESOURCES

