



XAVL-2021-DPRS

Project _____
 Item _____
 Quantity _____
 Date _____

Model
**CHEFTOP MIND.Maps™ PLUS
 BIG**

- Combi steamer
- Electric
- 20 trays GN 2/1
- Hinge on the left side (Right hand door)
- 9.5" Touch control panel



DESCRIPTION

Technologically advanced combi oven for gastronomy cooking processes (dehydrating, steaming, low temperature cooking, sous vide cooking, roasting, grilling, pan frying, regeneration and plate regeneration) and for fresh or frozen baking thanks to Unox Intensive Cooking and Intelligence Performance technologies which guarantee perfect results and repeatability for any load size. Automatic management of cooking processes (CHEFUNOX) for perfect results even without trained staff.

STANDARD COOKING FEATURES

Programs

- 1000+ Programs
- **CHEFUNOX**: choose something to cook from the library and the oven will automatically set all the parameters
- **MULTI.TIME**: manages up to 10 cooking processes at the same time
- **MISE.EN.PLACE**: synchronises the insertion of pans so that all the dishes are ready at the same time
- **MIND.Maps™**: draw the cooking processes directly on the display
- **READY.COOK**: ready to use settings with infinite time for a quick start

Manual cooking

- **Temperature**: 86 °F – 572 °F
- Up to 9 cooking steps
- **CLIMA.Control**: humidity or dry air set by 10%
- Delta T cooking with core probe
- SOUS-VIDE cooking
- 4-speed fan system

STANDARD TECHNICAL FEATURES

- **ROTOR.Klean™**: automatic washing system
- Automatic special washing behind the fan guard
- Cooking chamber in high-resistance AISI 316L stainless steel with rounded edges
- Triple glass
- Cooking chamber lighting through LED lights embedded in the door
- Tray supports with anti-tip system
- High-performance heating elements
- Integrated DET&Rinse™ detergent container
- Integrated Wi-Fi
- **Wi-Fi / USB data**: download/upload HACCP data
- **Wi-Fi / USB data**: download/upload programs
- Fully integrated drain cooling valve (drain discharge temp. ≤ 140°F)

ADVANCED AND AUTOMATIC COOKING FEATURES

Data Driven Cooking

- Control and monitor the operating conditions of your ovens in real-time, create and share new recipes. The AI transforms the consumption data into useful information in order to increase your daily profit. Create, understand, improve

Unox Intelligent Performance

- **ADAPTIVE.Cooking™**: automatically regulates the cooking parameters to ensure repeatable results
- **CLIMALUX™**: total control of the humidity in the cooking chamber
- **SMART.Preheating**: automatically sets the preheating temperature and duration
- **AUTO.Soft**: manages the heat rise to make it more delicate
- **SENSE.Klean**: estimates how dirty the oven is and suggests the appropriate automatic washing cycle

Unox Intensive Cooking

- **DRY.Maxi™**: rapidly extracts the humidity from the cooking chamber
- **STEAM.Maxi™**: produces saturated steam
- **AIR.Maxi™**: manage fans auto-reverse and pulse function
- **PRESSURE.Steam**: increases the steam saturation and temperature

APP & WEB SERVICES

- Data Driven Cooking app & webapp
- Top Training app
- Combi guru app



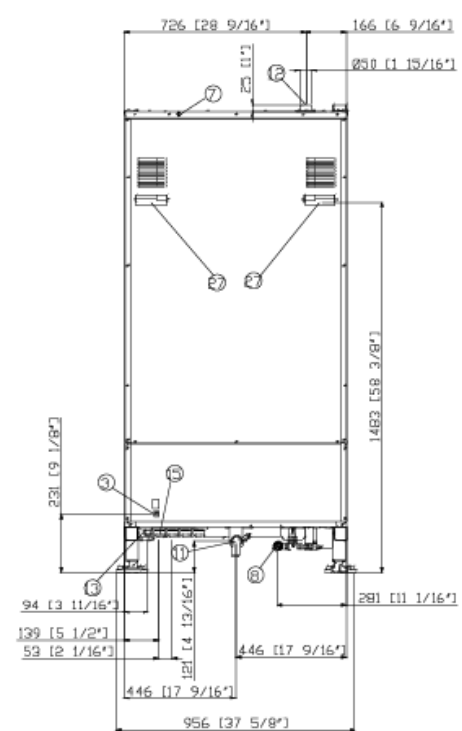
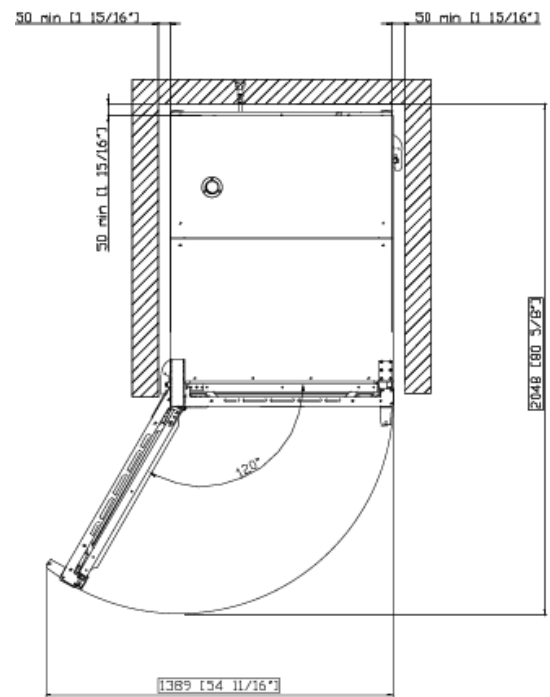
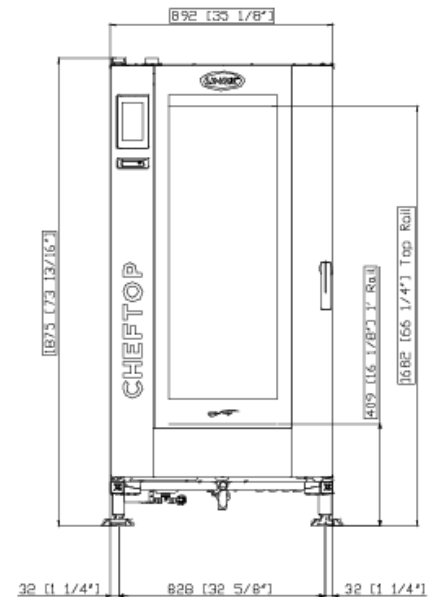
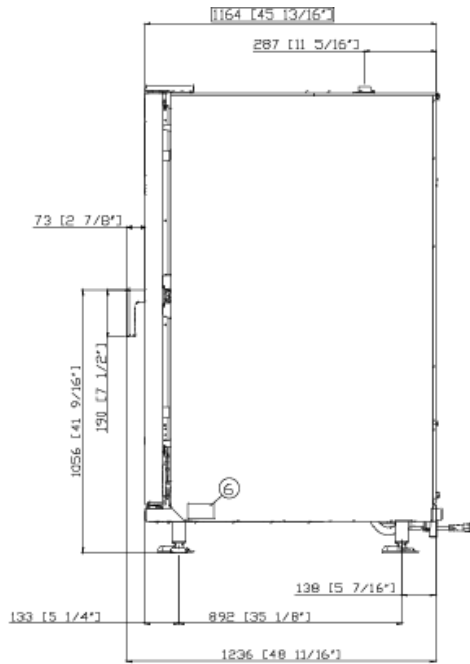

DIMENSIONS AND WEIGHT

Width	35-1/8"	892 mm
Depth	45-53/64"	1164 mm
Height	73-7/8"	1875 mm
Net Weight	748 lbs	339 kg
Tray pitch	2-11/16"	67 mm

CONNECTION POSITIONS

2 Terminal board power supply	10 Rotor.KLEAN™ inlet
3 Unipotential terminal	11 Chamber drain pipe
6 Technical data plate	12 Hot fumes exhaust chimney
7 Safety thermostat	13 Accessories connection
8 3/4" female NPT water inlet	27 Cooling air outlet



XAVL-2021-DPRS

Power and gas supply
 Water connections
 Installation requirements
 Accessories

POWER SUPPLY

STANDARD	
Voltage	240 V
Phase	~3PH+PE
Frequency	60 Hz
Total power	71 kW
Maximum Amp Draw	172.5 A
Required breaker size	80 A
Power cable requirements*	4 x AWG 00
Plug	NOT INCLUDED

OPTION A	
Voltage	208 V
Phase	~3PH+PE
Frequency	60 Hz
Total power	53.7 kW
Maximum Amp Draw	66 A
Required breaker size	70 A
Power cable requirements*	4 x AWG 000
Plug	NOT INCLUDED

*Recommended size - observe local ordinance. Cable not included.

WATER SUPPLY

USING A WATER SUPPLY THAT DOES NOT MEET UNOX'S MINIMUM WATER QUALITY STANDARDS WILL VOID ANY WARRANTY.

It is the responsibility of the purchaser to ensure that the incoming water supply is compliant with the listed specifications through adequate treatment measures.

Line pressure:	Drinking water inlet: 3/4" NPT*, line pressure: 22 to 87 psi; 1.5 to 6 Bar (29 psi; 2 Bar recommended)
----------------	--

Inflow water specifications

Free chlorine	≤ 0.5 ppm
Chloramine	≤ 0.1 ppm
pH	7 - 8.5
Electrical conductivity	≤ 1000 µS/cm
Total hardness	≤ 30 °dH

Steam circuit: inflow water specifications

Total hardness	≤ 8 °dH*
Chlorides	≤ 250 ppm

*this value refers to daily steam cooking of 1- 2 hours. In any case, if with a total hardness ≤ 8°dH there is still production of limescale, it is mandatory to treat the water in order to avoid limescale production. We recommend water treatment systems based on ion exchange resins. Water treatment systems based on polyphosphates are not allowed.

ACCESSORIES

- QUICK.Load and trolley system
- Cooking Essentials: special trays
- Sous-vide core probe
- DET&Rinse™ PLUS: cleaning and rinse agents to combine maximum cleanliness with minimum consumption and long life for your oven
- DET&Rinse™ ECO: eco formula for daily cleaning and the utmost respect for the environment. Ideal for mild level of dirt.
- DET&Rinse™ ULTRA: cleaning and rinse agents to combine maximum cleanliness with minimum consumption and long life for your oven
- Finest: resin-based filtering system that eliminates from the water all substances that contribute to the formation of limescale inside the oven cooking chamber
- Ethernet connection kit

INSTALLATION REQUIREMENTS

Installations must comply with all local electrical systems, particularly as for minimum wire gauge required for field connection, hydraulic and ventilation supply. Exhaust and fume analysis must be performed in case of gas ovens.

Register to access data and product specifications
www.ddc.unox.com