



**BEVERAGE-AIR®**

PROJECT: \_\_\_\_\_  
 ITEM # \_\_\_\_\_ QTY: \_\_\_\_\_  
 MODEL # \_\_\_\_\_  
 AIA # \_\_\_\_\_ SIS # \_\_\_\_\_  
 APPROVED: \_\_\_\_\_

## SANDWICH PREP TABLES

**Model: SPED72HC-24M-6**

**SIX DRAWERS MEGA TOP**

### 7 YEAR WARRANTY Parts, Labor, and Compressor

#### CABINET CONSTRUCTION

- Stainless steel front, sides, top, drawers, and grille (galvanized steel back & bottom)
- Interior liner is made of corrosion resistant aluminum
- Removable hoods made of matching stainless steel
- Full electronic control
- Airflow assures that product in open containers is kept below 41°F and above freezing
- (24) 1/6 size 4" deep pans constructed of polycarbonate plastic
- Pans furnished are 4" deep constructed of polycarbonate plastic
- Snap-in magnetic gaskets for positive drawer seal
- Painted aluminum handles
- 10" Wide cutting board constructed of white polyethylene plastic
- Cutting board removable for cleaning
- Stainless steel drawer frames supported on telescoping drawer slides
- Drawer slides include locking mechanism that prevents drawers from being inadvertently pulled off cabinet
- 6" Casters, with (2) brakes standard



#### OPTIONS & ACCESSORIES

- Stainless steel back
- Stainless steel interior
- Clear lid
- Overshelves (single or double)
- Crumb catcher kit
- Richlite cutting board
- Night cover
- Bottle organizer
- Pan supports
- Pan support crossbar
- Pan configuration
- Locking divider
- 6" Legs or 3" casters
- Low profile casters
- Remote option\* (see note on back page)

#### REFRIGERATION SYSTEM

- Uses environmentally friendly, energy efficient R290 refrigerant, and meets all regulatory requirements for CARB, SNAP, DOE & more
- Adaptive defrost
- Epoxy coated evaporator coil
- Enhanced airflow maintains temperature between 36° to 38°F



# BEVERAGE-AIR®

## Sandwich Prep Tables Model: SPED72HC-24M-6

PLAN VIEW

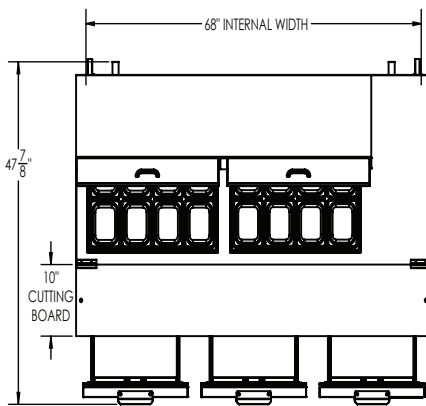

ELEVATION VIEW

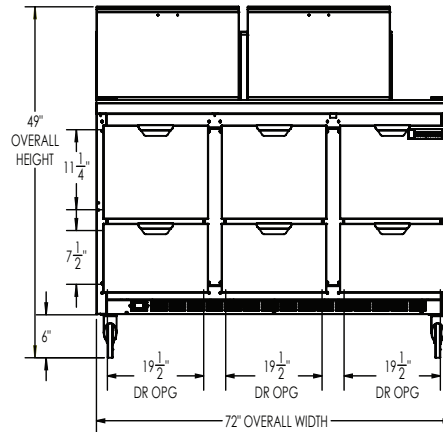

SIDE VIEW

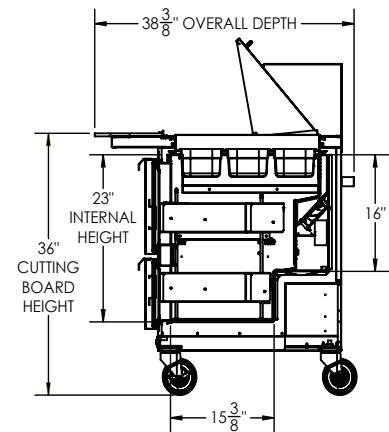

Required Clearance: 3" Bottom & 2" Rear

### EXTERNAL DIMENSIONAL DATA

Width Overall (in)	72"
Depth Overall (in)	38 3/8"
Height Overall (in)	49"
Number of Drawers	6
Depth, Cutting Board	10"

### INTERNAL DIMENSIONAL DATA

NET Capacity (cubic ft.)	20.02
Internal Width Overall (in)	68"
Internal Depth Overall (in)	15 3/8"
Internal Height Overall (in)	23"
Depth with Drawers Open	57 7/8"
Drawers Openings	29 1/2" x 11 1/4" 19 1/2" x 7 1/2"

\*NOTE: Remote units are field wired and come with 6" legs.  
Refrigerant must be specified at time of order.

### ELECTRICAL DATA

Full Load Amps	5.4
Voltage	115/60/1
Nema Plug (8' cord)	5-15P

### REFRIGERATION DATA

Horsepower	1/3
Capacity (BTU/Hr)	1549
Heat Rejection (BTU/Hr)	2323.5
Charge (lbs/grams/ounces)	0.2095 / 95 / 3.35

### SHIPPING DATA

Gross Weight - Crated	496 lbs.
Height - Crated (in)	44"
Width - Crated (in)	74"
Depth - Crated (in)	35"

### ELECTRICAL CONNECTION



115/60/1  
NEMA 5-15P

Unit pre-wired at factory and include 8' long cord and plug set.

We reserve the right to change specifications and product design without notice. Such revisions do not entitle the buyer to corresponding changes, improvements, additions or replacements for previously purchased equipment. Dimensional tolerances +/- 1/4". Metric dimensions (MM).

3779 Champion Blvd., Winston-Salem, NC 27105 | 888-845-9800 | Fax: 336-245-6453 | Beverage-Air.com | Sales@bevair.com

Date Issued 2/26 | Printed in U.S.A.