

"UBIB-18-CP7" UNDERBAR ICE BIN

Slim-Line, 18" Width, w/7 Circuit Cold Plate

FEATURES:

- 18GA Stainless Steel Construction
- Type 300 Stainless Steel With #4 Polish, Satin Finish
- Slim Line 18" Deep Front To Back
- Foam Insulated Ice Bin
- 7 Circuit Cold Plate
- Standard Threaded Inserts On Sides For Attaching Adjacent Units Together
- Standard Front Inserts For Speed Rail Attachment
- Access Plates On Top Of Backsplash For Soda Gun Lines
- Stainless Steel Front To Back Bracing

SPECIFICATIONS:

- Top: 18GA Type 300 Stainless Steel
- Front Apron: 18GA Type 300 Stainless Steel
- Backsplash: 18GA Type 300 Stainless Steel
- Sides: 18GA Type 300 Stainless Steel
- Bolt On 1-5/8" Stainless Steel Legs For Fast Installation
- 1-1/4" Front To Back Bracing
- 1" Adjustable Stainless Steel Bullet Feet
- Z-Clip To Mount To Wall
- Bolt To Adjacent Underbar Piece
- Legs Not To Be Removed On Ice Bins
- 1-7/8" Drain Plug
- 1" MPT 3-1/4" Long Drain Connection



UBIB-1824-CP7

CERTIFICATIONS:



ACCESSORIES

MODEL	DESCRIPTION
UBSS-18-L	Slim-Line Left Hand Side Splash
UBSS-18-R	Slim-Line Right Hand Side Splash
UBSR1-24	24" Single Speed Rail
UBSR1-30	30" Single Speed Rail
UBSR1-36	36" Single Speed Rail
UBSR2-24	24" Double Speed Rail
UBSR2-30	30" Double Speed Rail
UBSR2-36	36" Double Speed Rail
UBIBL-1824-BWH	Bottle Well Holder With Lid For 24"x18" Ice Bin
UBIBL-1830-BWH	Bottle Well Holder With Lid For 30"x18" Ice Bin
UBIBL-1836-BWH	Bottle Well Holder With Lid For 36"x18" Ice Bin

"UBIB-18-CP7" UNDERBAR ICE BIN WITH COLD PLATE

MODEL	SIZE (LXWXH)	LENGTH (L)	WEIGHT (LBS)
UBIB-1824-CP7	24"x18"x32-1/2"	24"	172
UBIB-1830-CP7	30"x18"x32-1/2"	30"	182
UBIB-1836-CP7	36"x18"x32-1/2"	36"	191

ALL DIMENSIONS ARE TYPICAL. TOLERANCE +/- .500". JOHN BOOS & CO. RESERVES THE RIGHT TO CHANGE SPECIFICATIONS WITHOUT NOTICE.

DETAILED SPECIFICATIONS

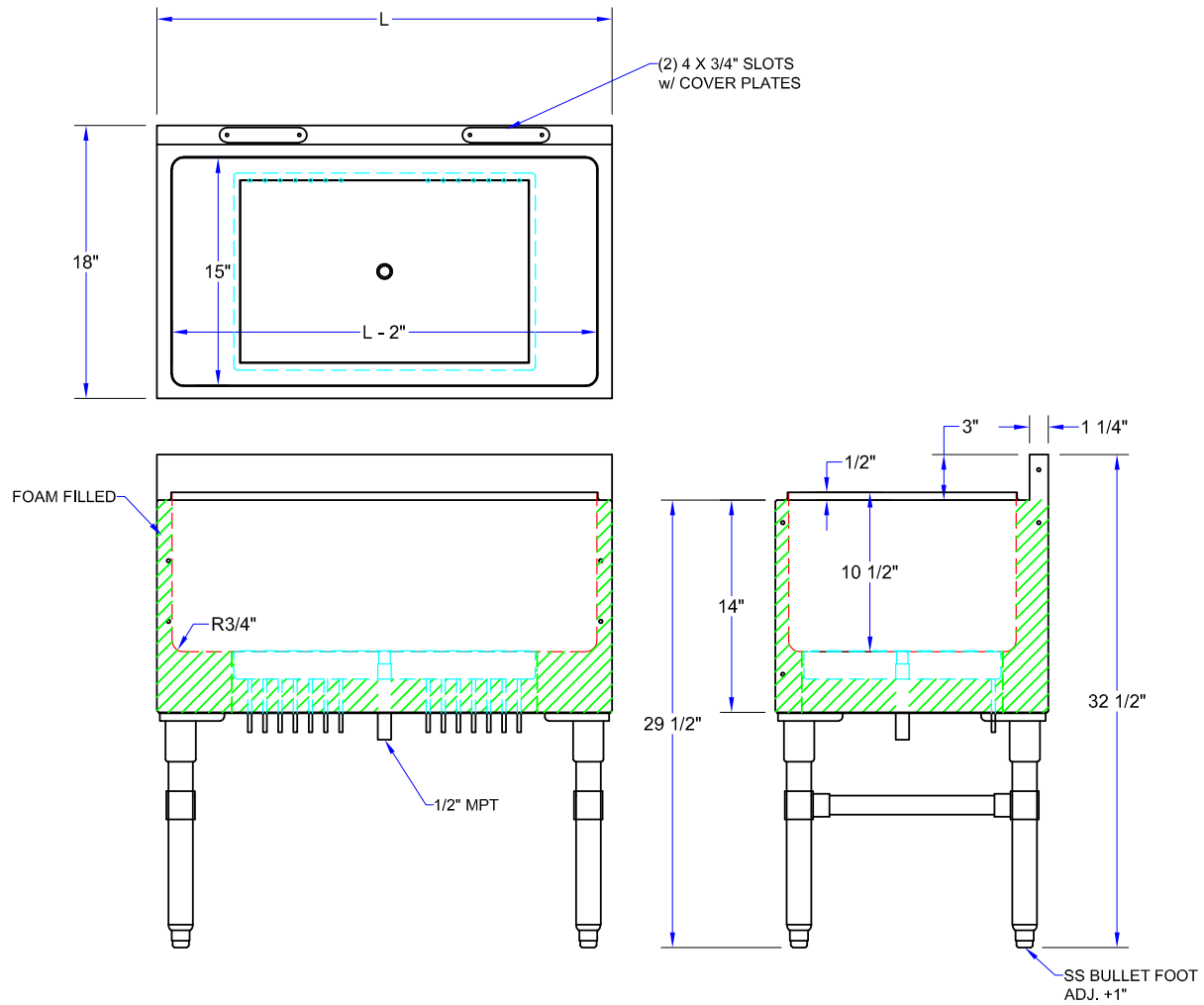

"UBIB-18-CP7" UNDERBAR ICE BIN WITH COLD PLATE

MODEL	SIZE (LXWXH)	LENGTH (L)	WEIGHT (LBS)
UBIB-1824-CP7	24"x18"x32-1/2"	24"	172
UBIB-1830-CP7	30"x18"x32-1/2"	30"	182
UBIB-1836-CP7	36"x18"x32-1/2"	36"	191

ALL DIMENSIONS ARE TYPICAL. TOLERANCE +/- .500". JOHN BOOS & CO. RESERVES THE RIGHT TO CHANGE SPECIFICATIONS WITHOUT NOTICE.