

COLD WALL MILK COOLERS

Model: MC4NSSDCW

Natural Refrigerant R-290 Model

49" Cold Wall Milk Cooler Dual Access



ENERGY STAR® Qualified Commercial Refrigerator

Stainless steel exterior and interior, heavy-duty stainless steel lid(s), door hinges and latches with reinforced stainless steel floor.
Designed to keep milk cold during serving.



Options and Accessories

(upcharge and lead times may apply)

Wrap around bumpers	Color laminate
Corner bumpers	Floor foot pedal lock

Consult factory for other model configurations, options and accessories.



Project Name:

Model Specified:

Location:

Item No: Quantity:

AIA #: SIS #:

Standard Model Features

REFRIGERATION SYSTEM

Cold wall, performance rated refrigeration system

Natural, environmentally safe, high efficiency R-290 refrigerant¹

Easily serviceable, bottom-mounted condensing unit

CABINET ARCHITECTURE

2" high density, non-CFC polyurethane foamed-in-place insulation

Snap in lids and door gaskets

Non-corrosive, heavy duty, epoxy coated steel wire floor racks

Cylinder keyed security locks

5" diameter swivel plate casters with front locking brakes

MODEL FEATURES

Electronic controller with digital display & hi-low alarm

Floor drain

¹ R-290 refrigerant meets all federal and state regulatory requirements.

APPROVAL:

Model Specifications

DIMENSIONAL DATA

Net Capacity (cubic feet)	20.0 (566 l)
Crate Capacity (13" x 13" x 11")	12
Crate Capacity (19" x 13" x 11")	8
Width, Overall (inches)	49 (1245 mm)
Depth, Overall (inches)	33 (838 mm)
Height, Overall (inches) (including 5" casters)	41 1/2 (1054 mm)

REFRIGERANT DATA

Condensing Unit Size (H.P.)	1/3
R-290 Refrigerant Charge (oz)	3.2
Capacity (BTU per hour)*	1870

ELECTRICAL DATA

Voltage (International)	115/60/1 (220/50/1)
Total Amps (International)	3.4 (1.7)
10 ft. Cord/Plug [attached] (International)	Yes (No)

SHIPPING DATA

Weight (pounds)	485 (220 kg)
Height - Crated (inches)	56 (1429 mm)
Width - Crated (inches)	58 (1480 mm)
Depth - Crated (inches)	37 (927 mm)

* Rating @ +10°F evaporator, 90°F ambient
Figures in parentheses reflect metric equivalents rounded to the nearest whole unit.



Equipped with one NEMA-5-15P Plug
(varies by country)

Model Plan Views

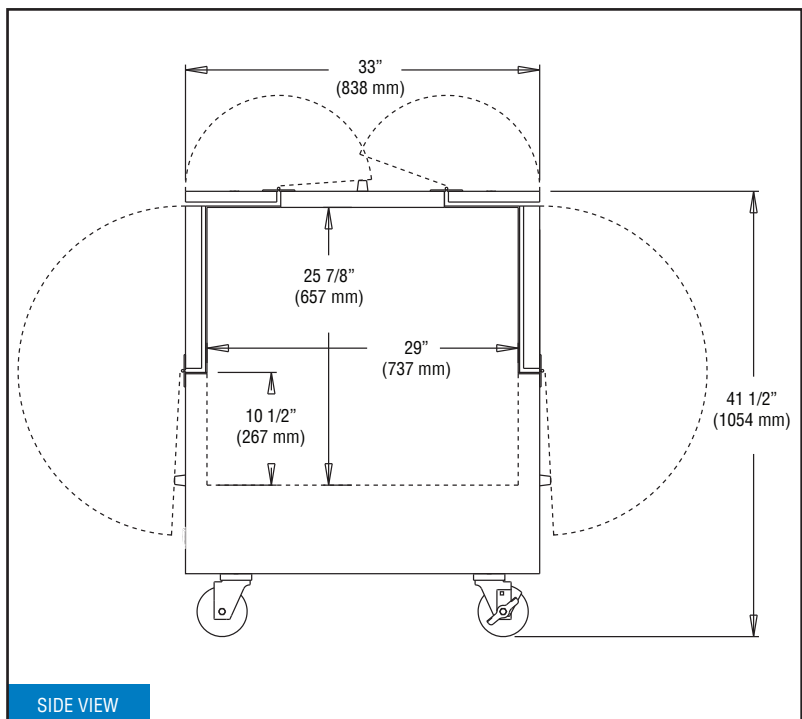
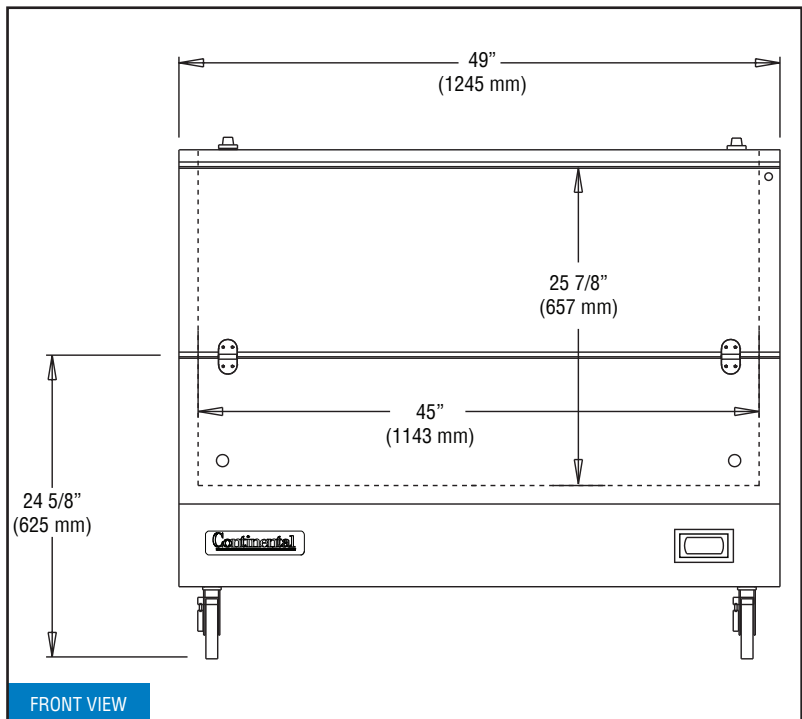

Continental
Refrigerator

Toll-Free: 800-523-7138
Phone: 215-244-1400
Fax: 215-244-9579

539 Dunksferry Road
Bensalem, PA 19020
www.continentalrefrigerator.com

Due to our continued efforts in developing innovative products, specifications subject to change without notice.



PROUDLY
DESIGNED & ASSEMBLED
IN THE U.S.A.

Intertek

© Copyright 2021. Continental Refrigerator.

REVISED: 4/29/26