

SANDWICH UNIT REFRIGERATOR

Model: SW36N8-FB

Natural Refrigerant R-290 Model

36" Standard Top Sandwich Unit Refrigerator with Solid Door - 8 Pans Front Breathing

Stainless steel front, top and end panels, aluminum back and interior.



Options and Accessories

(upcharge and lead times may apply)

Stainless steel interior	Flat lid
Stainless steel back	Vision panel lid
Additional epoxy coated steel shelves	Rear mounted cutting board
Stainless steel shelves	Composite cutting board
Overshelves (single or double)	Crumb catcher
Door locks	Modified pan opening

Consult factory for other model configurations, options and accessories.

Continental
Refrigerator



Project Name:

Model Specified:

Location:

Item No:

Quantity:

AIA #:

SIS #:

Standard Model Features

REFRIGERATION SYSTEM

Performance rated refrigeration system

Natural, environmentally safe, high efficiency R-290 refrigerant¹

Unique air flow distribution allows pan product to maintain 33° - 41°F

Automatic, hot gas condensate evaporator

Non-corrosive, plasticized fin evaporator coil

Easily serviceable, back mounted compressor

CABINET ARCHITECTURE

2" non-CFC polyurethane foam insulation

Smooth, polished chrome door handles

Spring loaded, self closing doors

Magnetic snap in Santoprene™ door gaskets

Heavy duty, epoxy coated steel shelves

12" deep, full length nylon cutting board

Insulated lid

Completely enclosed, vented and removable case back

3 3/4" casters

MODEL FEATURES

(8) 1/6 size recessed pans, 4" deep

Removable interior tub below pans

Electronic control, off-cycle defrost

Field rehingeable doors

¹ R-290 refrigerant meets all federal and state regulatory requirements.

Front breathers are a unique, field assembled, bottom mounted ventilation system designed to allow cabinets to be flush against a wall or built into a counter to conserve space. For proper operation, the area under and in front of the cabinet must not be obstructed in any way.

APPROVAL:

Model Specifications

DIMENSIONAL DATA

Net Capacity (cubic feet)	10.3 (292 l)
1/6 Size Pans (4" deep)	8
Width, Overall (inches)	36 (914 mm)
Depth, Overall (inches) (including handles & bumpers)	32 3/16 (818 mm)
Depth, Cutting Board (inches)	12 (305 mm)
Height, Overall (inches) (including 3 3/4" casters)	41 (1041 mm)
Shelf Area (square feet)	4.6 (0.4 sq m)
Number of Shelves	2
Number of Doors	2
Interior Depth (inches)	19 3/8 (492 mm)
Interior Height (inches)	26 1/4 (667 mm)
Interior Width (inches)	32 (813 mm)

REFRIGERANT DATA

Condensing Unit Size (H.P.)	1/5
R-290 Refrigerant Charge (oz)	3.4
Capacity (BTU per hour)*	1390

ELECTRICAL DATA

Voltage (International)	115/60/1 (220/50/1)
Total Amps (International)	2.5 (1.3)
10 ft. Cord/Plug [attached] (International)	Yes (No)

SHIPPING DATA

Weight (pounds)	275 (125 kg)
Height - Crated (inches)	43 1/4 (1099 mm)
Width - Crated (inches)	44 (1118 mm)
Depth - Crated (inches)	37 1/4 (946 mm)

* Rating @ +25°F evaporator, 90°F ambient
Figures in parentheses reflect metric equivalents rounded to the nearest whole unit.



Equipped with one NEMA-5-15P Plug
(varies by country)

Continental[®]

Refrigerator

Toll-Free: 800-523-7138
Phone: 215-244-1400
Fax: 215-244-9579

539 Dunksferry Road
Bensalem, PA 19020
www.continentalrefrigerator.com

Due to our continued efforts in developing innovative products, specifications subject to change without notice.



PROUDLY
DESIGNED & ASSEMBLED
IN THE U.S.A.

© Copyright 2021. Continental Refrigerator.
A Division of National Refrigeration & Air Conditioning Products, Inc.

Model Plan Views

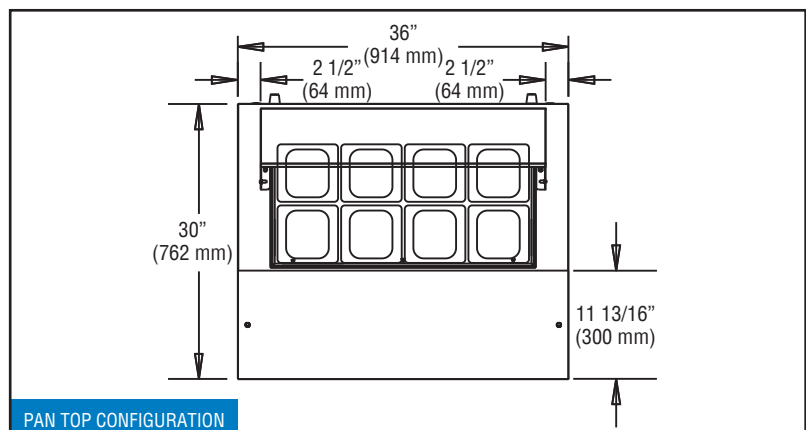
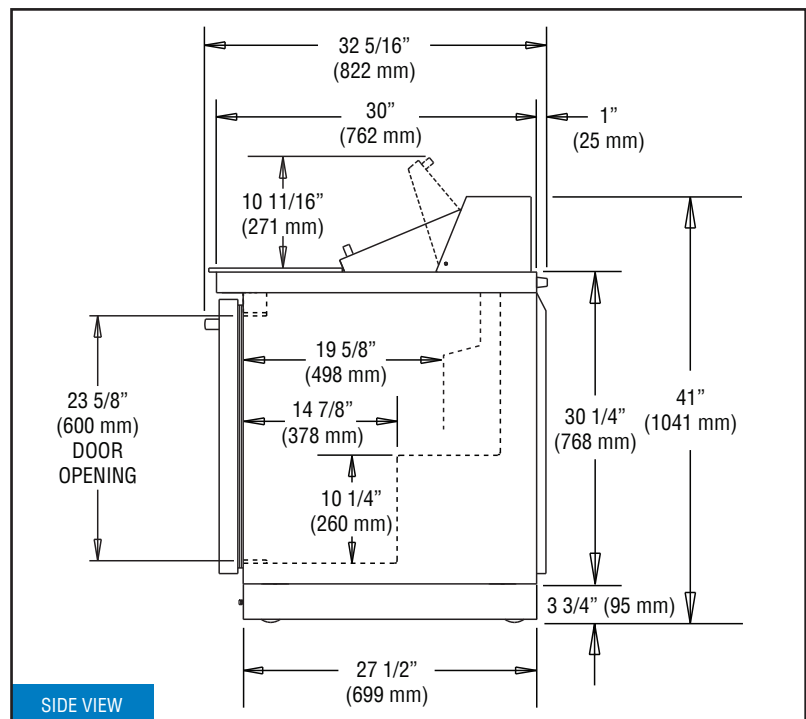
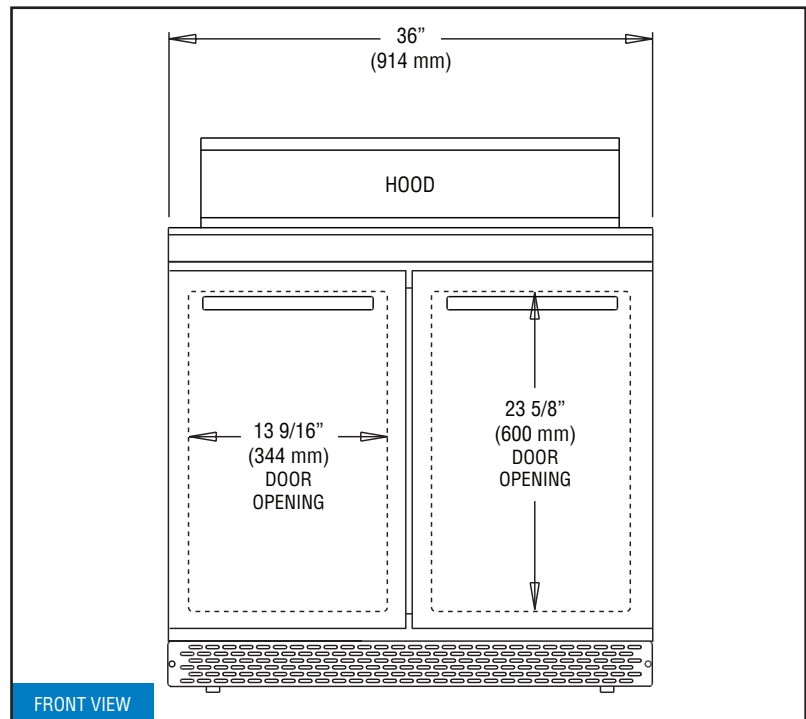

REVISED: 12/4/25