

# Garland Induction Built-in Wok 3.5, 5.0 and 8.0 kW

Project \_\_\_\_\_  
Item \_\_\_\_\_  
Quantity \_\_\_\_\_  
CSI Section 11400  
Approved \_\_\_\_\_  
Date \_\_\_\_\_

## Models

- GI-SH/WO/IN 3500
- GI-SH/WO/IN 5000
- GI-SH/WO/IN 8000



### Installation Notes:

The unit is designed to be installed into a counter. An integral cooling fan keeps the electronics cool. Garland offers an air intake kit, recommended for all enclosed installations.

The unit takes cooling air in from the bottom, and discharges from both sides. The air intake kit connects directly to the unit. A minimum of 10 sq. inch (65 sq. cm) opening for the exhaust must be allowed for proper operation in the design of the cabinet.

## Standard Features

- Drop-in, flush mounted design with stainless steel body below counter bowl to accept wok pan
- Remote control and indicator light mounted on a control panel plate with a 3 foot (914mm) cable
- Integral cooling fan keeps electronics cool and provisions must be made to allow for air intake and exhaust when mounted in a counter
- 6' (1829mm) cord and plug supplied.
- "Flat Design", compact high performance electronics
- Thermostatically controlled overheat sensor shuts the unit off preventing damage from pans cooking dry
- Instant energy transmission to the pan
- Induction technology transfers heat to the pan, not to the surrounding air
- Innovated new technology for pan detection; RTCS is an internal control software development matching speed, capability and performance.
- R - Real Time
- T - Temperature
- C - Control
- S - System
- Electronic output limitation continually monitors the energy transfer to the pan, helping to ensure the most efficient energy transfer possible
- Available in 3.5 kW, 5.0 kW and 8.0 kW
- Built-Air-In-Take-Kit (part number 95000021) includes:
  - Aluminum Spiroflex air duct, 5m
  - Grease filter
  - Mounting Kit

## Options & Accessories

- High quality induction stainless steel wok pan: 5.2 liter and 9.5 liter are available.

## Specifications

Shall be a Garland Single Drop-In Induction Wok, model GI-SH/WO/IN 3500 with a total kilowatt rating of 3.5kW, model GI-SH/WO/IN 5000 with a total kilowatt rating of 5.0 kW, or model GI-SH/WO/IN 8000 with a total kilowatt rating of 8.0 kW. Drop in mounts flush with counter, built with a robust stainless steel casing with ceran ceramic glass bowl to accept an induction rounded pan. Compact powerful electronic system for years of reliable service. Overheat sensors help prevent damage if pan is run dry. Easy to operate system supplied with remote rotary mounted control. Unit comes in 208V or 240V (specify at time of order) with cord and plug for North America, other voltages available.

Note: Induction cooking requires "Induction Ready" pans to operate. Garland recommends that the wok pans used be the correct contour to the ceran glass. To reduce premature failures such as overheating. Wok pans should not touch the glass but only sit onto the upper case flange. Garland offers a number of wok induction pans.



CE models comply with the latest European Norms: EN 60335-1, EN 60335-2-36, EN 62233 (EMC/EMV)

North American models:  
ETL listed in compliance with UL 197, CSA C22.2 No.109, NSF-4  
Complies with FCC part 18, ICES-001

Garland Induction Built-in Wok 3.5, 5.0 and 8.0 kW

# Garland Induction Built-in Wok 3.5, 5.0 and 8.0 kW

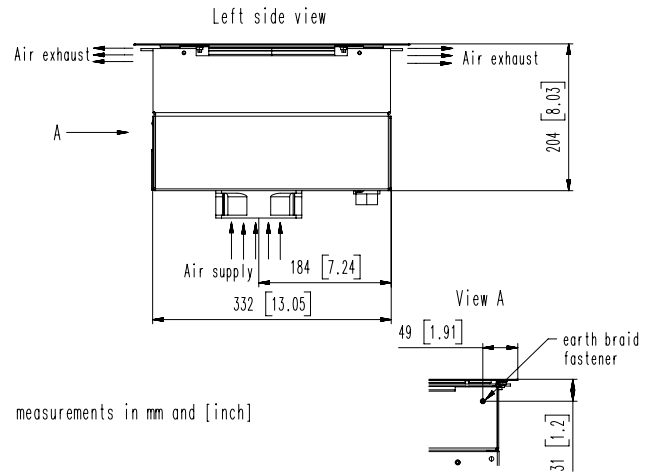
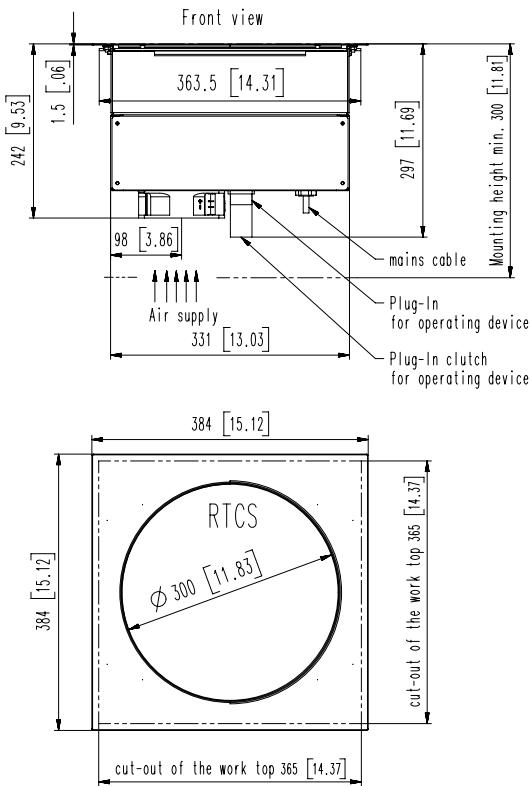

measurements in mm and [inch]

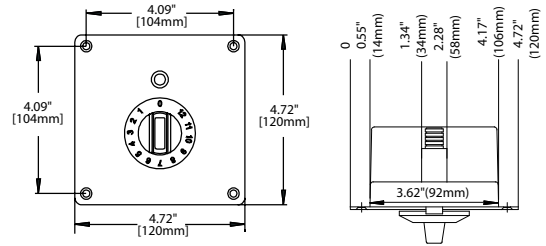





Garland/U.S. Range products are not approved or authorized for home or residential use, but are intended for commercial applications only. Garland / U.S. Range will not provide service, warranty, maintenance or support of any kind other than in commercial applications.

Electrical Loading				
Model	Watts	208/60/1	240/60/1	230/50/1
GI-SH/WO/IN 3500	3500	16 amp	14 amp	15 amp

Electrical Loading				
Model	Watts	208/60/3	400/50/3	440/50/3
GI-SH/WO/IN 5000	5000	14 amp	8 amp	7 amp

Electrical Loading		
Model	Watts	400/50/3
GI-SH/WO 5000	5000	14 amp

Plug Configurations		
Model	Electrical Characteristics	Plug
GI-SH/BA 3500	208V/60Hz/1Ø 240V/60Hz/1Ø	 <b>NEMA 6-20P</b>
	230V/50Hz/1Ø	 <b>EU1-16P</b>
GI-SH/BA 5000	208V/60Hz/3Ø	 <b>L15-20P</b>
	400V/50Hz/3Ø	 <b>EU 5-Pole</b>
	440V/50Hz/3Ø	Plug not included

Welbilt reserves the right to make changes to the design or specifications without prior notice.