

# RECTANGULAR SINAQUA

Drop-in Waterless Buffet Warmer

## TWO-SENSOR UNIT



INCLUDES TWO CONTROLLERS

## THREE- AND SIX- SENSOR UNITS



INCLUDES THREE CONTROLLERS

### PERFORMANCE

The CookTek® Drop-in SinAqua™ is a waterless buffet warmer featuring an aluminum housing and a high-impact polycarbonate interior surface. The SinAqua™ requires no water lines or drains and has precise temperature holding for each pan to maximize food quality. Each unit is programmed with an automatic pan detection feature to ensure maximum and efficient warming of induction-compatible pans.\*

### EXTERIOR CONSTRUCTION

- Available in 100–120 or 200–240 VAC, single phase
- Available in 2.5" (two sensors), 4", or 6" (two, three, or six sensors) depths
  - Two sensors (two temperature zones or two controllers) can accommodate a standard hotel or gastronorm pans, or up to two half-size pans.
  - Three sensors (three temperature zones or three controllers) can accommodate a standard hotel or gastronorm pan, or up to three 1/3 pans
  - Six sensors (three temperature zones/three controllers) can accommodate a standard hotel or gastronorm pan, up to three 1/3 pans, or up to six 1/6 pans
- Waterless design – no water or drains needed
- Drop-in design with aluminum housing and a high-impact, easy-to-clean polycarbonate interior surface
- Four standard set temperatures, with additional options available through the controller and LED display
- Automatic pan detection allows for instant energy transmission to pan; almost no energy consumption when pan is not present
- Lock feature prevents unwanted setting changes
- Microprocessors monitor vital components to check for overheating, power supply issues, and more

### STANDARD INCLUDED ACCESSORIES

- Standard Cat 5e or Cat 6 patch cable from unit to control box
- 6-ft (1.8 m) nominal plug and cord
- One-year limited parts and labor warranty (U.S. and Canada)

### OPTIONAL ACCESSORIES

- Stainless-Steel Countertop Housing for Two-Sensor Unit (#302049)
- Stainless-Steel Countertop Housing for Three and Six-Sensor Unit (#302050)



\*SinAqua Drop-in Buffet Warmers are designed to be used with induction-compatible pans. It is the owner and installer's responsibility to comply with all local codes. CookTek reserves the right to substitute components or change specifications without prior notice.

IHWR-SPC-A / January 2026

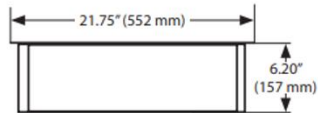

2.5" Depth Side View

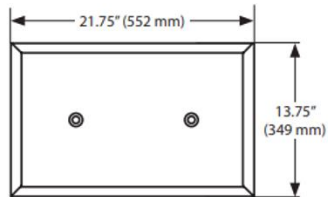

Two (2) Sensor Top View

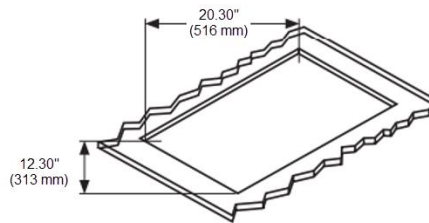

Countertop Cutout Dimensions

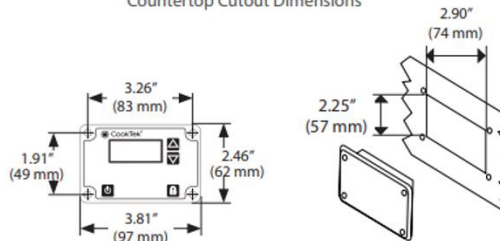

Controls Cutout Dimensions (Two-Sensor Unit Includes Two Controllers)

2.5" DIMENSIONS		
Full Unit Height	6.37"	162 mm
Full Unit Width	13.75"	349 mm
Full Unit Depth	21.75"	552 mm
Internal (Usable) Height	2.5"	64 mm
Internal (Usable) Width	12.18"	309 mm
Internal (Usable) Depth	20.18"	513 mm
Cutout Width	12.30"	313 mm
Cutout Depth	20.30"	516 mm
Weight	17 lb	7.7 kg
CLEARANCE		
Front	2"	51 mm
Sides	2"	51 mm
Rear	2"	51 mm
Below	6"	152 mm

SHIPPING INFORMATION		
Packaged Height	12"	305 mm
Packaged Width	18"	457 mm
Packaged Depth	24"	610 mm
Packaged Weight	25.9 lb	11.7 kg
Item Class	250 NMFC #26710	



NEMA 5-15P



NEMA 6-20P

ELECTRICAL SPECIFICATIONS – SINGLE PHASE (TWO SENSOR)			
UNITED STATES/CANADA			
IHW061-22	635701	100–120 VAC, 50/60 Hz, 650 W	NEMA 5-15P
IHW062-22	635801	200–240 VAC, 50/60 Hz, 650 W	NEMA 6-20P

⚠️ Dedicated circuit required for each installation

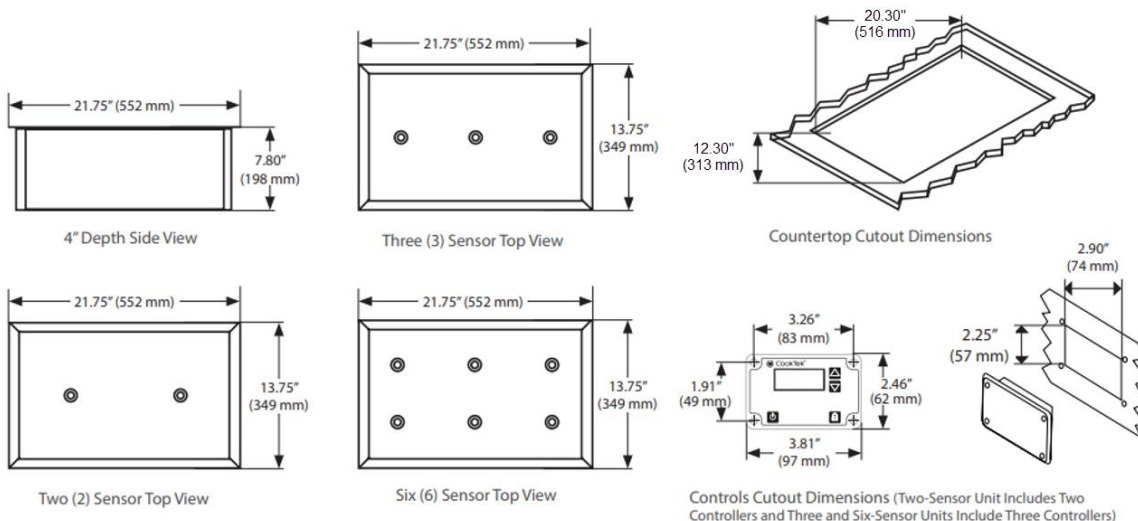

4" DIMENSIONS		
Full Unit Height	7.84"	199 mm
Full Unit Width	13.75"	349 mm
Full Unit Depth	21.75"	552 mm
Internal (Usable) Height	4"	102 mm
Internal (Usable) Width	12.18"	309 mm
Internal (Usable) Depth	20.18"	513 mm
Cutout Width	12.30"	516 mm
Cutout Depth	20.30"	313 mm
Weight	17 lb	7.7 kg
CLEARANCE		
Front	2"	51 mm
Sides	2"	51 mm
Rear	2"	51 mm
Below	6"	152 mm

SHIPPING INFORMATION		
Packaged Height	12"	305 mm
Packaged Width	18"	457 mm
Packaged Depth	24"	610 mm
Packaged Weight	25.9 lb	11.7 kg
Item Class	250 NMFC #26710	

	AS/NZS 3112:2000, 10 A, 250 V		CEE 7/7 Schuko, 16 A, 250 V		SI 32, 16 A, 250 V
--	-------------------------------------	--	-----------------------------------	--	--------------------

	BS1363, 13 A, 230 V		NEMA 5-15P
	BS 546, 16 A, 250 V		NEMA 6-20P

ELECTRICAL SPECIFICATIONS – SINGLE PHASE (TWO SENSOR)			
UNITED STATES/CANADA			
IHW061-24	635501	100–120 VAC, 50/60 Hz, 650 W	NEMA 5-15P
IHW062-24	635601	200–240 VAC, 50/60 Hz, 650 W	NEMA 6-20P

ELECTRICAL SPECIFICATIONS – SINGLE PHASE (THREE SENSOR)			
UNITED STATES/CANADA			
IHW061-34	638201	100–120 VAC, 50/60 Hz, 600 W	NEMA 5-15P
IHW062-34	638401	200–240 VAC, 50/60 Hz, 600 W	NEMA 6-20P
UK/MIDDLE EAST			
IHW062-34	638402	200–240 VAC, 50/60 Hz, 600 W	BS1363, 13 A, 230 V
INTERNATIONAL			
IHW062-34	638403	200–240 VAC, 50/60 Hz, 600 W	CEE 7/7 Schuko, 16 A, 250 V
AUSTRALIA			
IHW062-34	638404	200–240 VAC, 50/60 Hz, 600 W	AS/NZS 3112:2000, 10 A, 250 V
SOUTH AFRICA			
IHW062-34	638407	200–240 VAC, 50/60 Hz, 600 W	BS 546, 16 A, 250 V
ISREAL			
IHW062-34	638408	200–240 VAC, 50/60 Hz, 600 W	SI 32, 16 A, 250 V

ELECTRICAL SPECIFICATIONS – SINGLE PHASE (SIX SENSOR)			
<b>UNITED STATES/CANADA</b>			
IHW061-64	661601	100–120 VAC, 50/60 Hz, 600 W	NEMA 5-15P
IHW062-64	661701	200–240 VAC, 50/60 Hz, 600 W	NEMA 6-20P
<b>UK/MIDDLE EAST</b>			
IHW062-64	661702	200–240 VAC, 50/60 Hz, 600 W	BS1363, 13 A, 230 V
<b>INTERNATIONAL</b>			
IHW062-64	661703	200–240 VAC, 50/60 Hz, 600 W	CEE 7/7 Schuko, 16 A, 250 V
<b>AUSTRALIA</b>			
IHW062-64	661704	200–240 VAC, 50/60 Hz, 600 W	AS/NZS 3112:2000, 10 A, 250 V
<b>SOUTH AFRICA</b>			
IHW062-64	661707	200–240 VAC, 50/60 Hz, 600 W	BS 546, 16 A, 250 V
<b>ISREAL</b>			
IHW062-64	661708	200–240 VAC, 50/60 Hz, 600 W	SI 32, 16 A, 250 V

⚠️ Dedicated circuit required for each installation

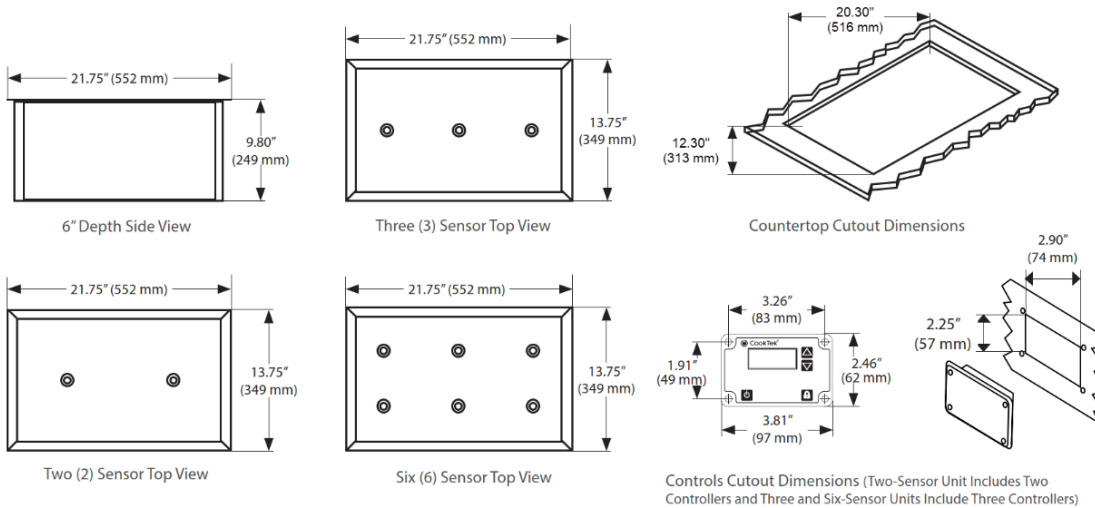

6" DIMENSIONS		
Full Unit Height	9.83"	249 mm
Full Unit Width	13.75"	349 mm
Full Unit Depth	21.75"	552 mm
Internal (Usable) Height	6"	152 mm
Internal (Usable) Width	12.18"	309 mm
Internal (Usable) Depth	20.18"	513 mm
Cutout Width	12.30"	313 mm
Cutout Depth	20.30"	516 mm
Weight	17 lb	7.7 kg
CLEARANCE		
Front	2"	51 mm
Sides	2"	51 mm
Rear	2"	51 mm
Below	6"	152 mm

SHIPPING INFORMATION		
Packaged Height	12"	305 mm
Packaged Width	18"	457 mm
Packaged Depth	24"	610 mm
Packaged Weight	25.9 lb	11.7 kg
Item Class	250 NMFC #26710	

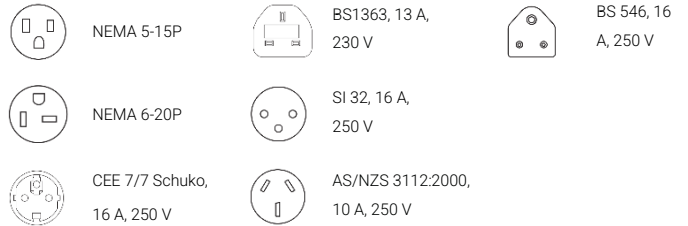

ELECTRICAL SPECIFICATIONS – SINGLE PHASE (TWO SENSOR)			
UNITED STATES/CANADA			
IHW061-26	671101	100–120 VAC, 50/60 Hz, 650 W	NEMA 5-15P
IHW062-26	671201	200–240 VAC, 50/60 Hz, 650 W	NEMA 6-20P

ELECTRICAL SPECIFICATIONS – SINGLE PHASE (THREE SENSOR)			
UNITED STATES/CANADA			
IHW061-36	638101	100–120 VAC, 50/60 Hz, 600 W	NEMA 5-15P
IHW062-36	638301	200–240 VAC, 50/60 Hz, 600 W	NEMA 6-20P
UK/MIDDLE EAST			
IHW062-36	638302	200–240 VAC, 50/60 Hz, 600 W	BS1363, 13 A, 230 V
INTERNATIONAL			
IHW062-36	638303	200–240 VAC, 50/60 Hz, 600 W	CEE 7/7 Schuko, 16 A, 250 V
AUSTRALIA			
IHW062-36	638304	200–240 VAC, 50/60 Hz, 600 W	AS/NZS 3112:2000, 10 A, 250 V
SOUTH AFRICA			
IHW062-36	638307	200–240 VAC, 50/60 Hz, 600 W	BS 546, 16 A, 250 V
ISREAL			
IHW062-36	638308	200–240 VAC, 50/60 Hz, 600 W	SI 32, 16 A, 250 V

ELECTRICAL SPECIFICATIONS – SINGLE PHASE (SIX SENSOR)			
<b>UNITED STATES/CANADA</b>			
IHW061-66	661801	100–120 VAC, 50/60 Hz, 600 W	NEMA 5-15P
IHW062-66	661901	200–240 VAC, 50/60 Hz, 600 W	NEMA 6-20P
<b>UK/MIDDLE EAST</b>			
IHW062-66	661902	200–240 VAC, 50/60 Hz, 600 W	BS1363, 13A, 230V
<b>INTERNATIONAL</b>			
IHW062-66	661903	200–240 VAC, 50/60 Hz, 600 W	CEE 7/7 Schuko, 16A, 250V
<b>AUSTRALIA</b>			
IHW062-66	661904	200–240 VAC, 50/60 Hz, 600 W	AS/NZS 3112:2000, 10A, 250V
<b>SOUTH AFRICA</b>			
IHW062-66	661907	200–240 VAC, 50/60 Hz, 600 W	BS 546, 16A, 250V
<b>ISREAL</b>			
IHW062-66	661908	200–240 VAC, 50/60 Hz, 600 W	SI 32, 16A, 250V

⚠️ Dedicated circuit required for each installation