



SALAD DRIER ES-100 120/50-60/1

Capacity per cycle: 6 kg / 13 lb.



P/N 1000702



DYNAMIC PREPARATION
COMMERCIAL SALAD SPINNERS

SALES DESCRIPTION

- ✓ Fast, sleek, quiet, user-friendly, safe, smooth running commercial salad spinner.
- ✓ Designed to efficiently dry up to 6 kg / 13 lb of salad per cycle at a maximum speed of 900 rpm.
- ✓ Portable. Equipped with locking wheels. Cycle memory. 2-speed-appliance.

High production with full warranty

- ✓ Dry **lettuce and other vegetables** in 1-3 minutes.
- ✓ **High speed** (900 rpm) and productivity.
- ✓ Guaranteed product **quality**.

Sturdy and reliable

- ✓ Equipped with **powerful three-phase motors** controlled by a highly reliable electronic speed variator. This enables the salad driers to be connected to a single-phase electrical mains supply.
- ✓ Highest quality **stainless steel** body and basket. The stainless steel basket with aluminium base offers durability and stability over the competition.
- ✓ Transparent, heavy-duty, BPA-free lid for ease of control, equipped with a self-opening mechanism and safety device.

Advanced features

- ✓ **User friendly** control panel with **advanced options** like cycle selection.
- ✓ The unique **Vibration Control System** automatically controls the load distribution prior to initiation.
- ✓ The **motor braking** enables fast and smooth cut-off.
- ✓ All ES commercial salad driers are equipped with **braking castors**. This allows maximum comfort in the workplace, providing stability during operation and ease of movement for cleaning & storage.

More images

Do you want to see more images?

Salad spinners

INCLUDES

- ✓ Castors with brake.
- ✓ Stainless steel drying basket.

OPTIONAL

- Additional stainless steel drying basket.

ACCESSORIES

- Stainless steel basket set

SPECIFICATIONS

Capacity per load: 6 kg
 Capacity per operation (lettuces): 5-8
 Drainer hourly production: 120 kg - 360 kg
 Timer (min-max): 60" - 120" - 180"
 2 speed: (350 rpm - 900 rpm)
 Motor speed: 900 rpm
 Total loading: 550 W
 Electrical supply: 120 V / 50-60 Hz / 1~
 Plug: USA (NEMA 5-15P / 2P+G)

Basket dimensions: 342 mm x 337 mm

External dimensions (W x D x H)

- ✓ Width: 540 mm
 - ✓ Depth: 750 mm
 - ✓ Height: 665 mm
- Net weight: 48 kg
 Crated dimensions
 660 x 820 x 860 mm
 Gross weight: 55 kg



SAMMIC, S.L. · Basarte, 1
 20720 AZKOITIA (Gipuzkoa) · SPAIN

product sheet
 updated 18/11/2025



SALAD DRIER ES-100 120/50-60/1

Capacity per cycle: 6 kg / 13 lb.



P/N 1000702

DYNAMIC PREPARATION
COMMERCIAL SALAD SPINNERS

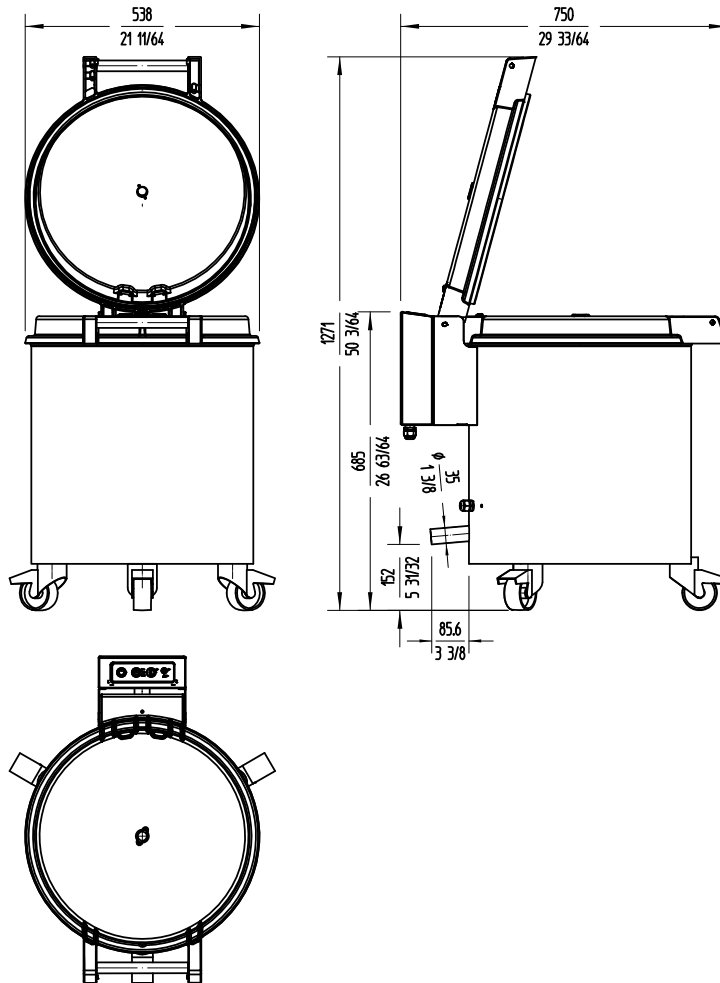

sammic | sammic.com
Food Service Equipment Manufacturer

Polígono Basarte, 1. phone +34 943 15 72 36
20720 Azkoitia, Spain sales@sammic.com



Project	Date
Item	Qty
Approved	

product sheet
updated 18/11/2025