



RESOURCES

Threaded Stem Casters

1/2" - 13 x 1" Threaded Stem Casters With Hard Rubber Wheel

Certifications:



Features:

- Double Ball Bearing Raceway for Long Wear and Added Strength
- With or Without Top Lock Brake
- Raceway Dust Cover

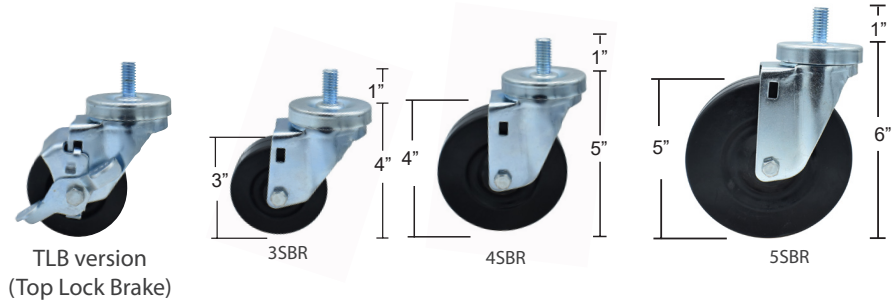

Material:

- High Impact Molded Rubber
- Temperature Range -40° to 160°F
- Nylon Bearing Sleeve
- Zinc Plated
- Hard Rubber Wheel

Part Number	Brake	Wheel Size	Capacity
3SBR-4ST-HR	-	3"	300 LBS
3SBR-4ST-HR-TLB	TLB	3"	300 LBS
4SBR-4ST-HR	-	4"	300 LBS
4SBR-4ST-HR-TLB	TLB	4"	300 LBS
5SBR-4ST-HR	-	5"	300 LBS
5SBR-4ST-HR-TLB	TLB	5"	300 LBS

PRODUCT DATA SHEET

RESOURCES

