

BASE MODEL SANDWICH UNIT

Model: RA93N30M-D

Natural Refrigerant R-290 Model

93" Mighty Top Sandwich Unit Refrigerator with Drawers - 30 Pans

Heavy gauge #300 series stainless steel top, stainless steel front and end panels, galvanized steel rear and grills and aluminum interior.



Options and Accessories

(upcharge and lead times may apply)

Stainless steel interior	Flat lid
Stainless steel back	Vision panel lid
Overshelves (single or double)	Door & drawer locks
Adjustable legs	Front breathing
Rear mounted cutting board	Compressor left (standard on right)
Composite cutting board	Drawer in lieu of door section above the condensing unit*

Consult factory for other model configurations, options and accessories.

*Drawer section above condensing unit holds (1) 12 x 20 x 6 pan.

Continental
Refrigerator



Project Name:

Model Specified:

Location:

Item No:

Quantity:

AIA #:

SIS #:

Standard Model Features

REFRIGERATION SYSTEM

Performance rated refrigeration system

Natural, environmentally safe, high efficiency R-290 refrigerant¹

Unique forced air design utilizes fans (approx. every 12") across the entire back of unit for even distribution of cold

Automatic, hot gas condensate evaporator

Non-corrosive, plasticized fin evaporator coil

Easily serviceable, slide out condensing unit

Expansion valve system

CABINET ARCHITECTURE

2" non-CFC polyurethane foam insulation

Smooth, polished chrome door & drawer handles

Spring loaded, self closing door over condensing unit

Magnetic snap in Santoprene™ door gaskets

Stainless steel roll out drawers

10" deep, full length nylon cutting board

Insulated lid

5" casters

MODEL FEATURES

Refrigerated section with door above the condensing unit

(30) 1/6 size recessed pans, 4" deep

Reversing condenser fan motor (runs for short period during startup to clear any debris)

Electronic control, off-cycle defrost

Field rehingeable door over condensing unit

¹ R-290 refrigerant meets all federal and state regulatory requirements.

NOTE: Models come standard with a door above the condensing unit. A drawer above the condensing unit is an option.

APPROVAL:

Model Specifications

DIMENSIONAL DATA

Net Capacity (cubic feet)	32 (906 l)
1/6 Size Pans (4" deep)	30
Width, Overall (inches)	93 (2362 mm)
Depth, Overall (inches) (including handles & bumpers)	37 (940 mm)
Depth, Cutting Board (inches)	10 (254 mm)
Height, Overall (inches) (including 5" casters)	42 (1067 mm)
Number of Drawers	6
Number of Half Doors	1
Interior Depth (inches) (above condenser)	30 (762 mm)
Interior Height (inches) (above condenser)	12 1/2 (318 mm)
Interior Width (inches) (above condenser)	17 (432 mm)

REFRIGERANT DATA

Condensing Unit Size (H.P.)	1/3
R-290 Refrigerant Charge (oz)	5.2
Capacity (BTU per hour)*	2540

ELECTRICAL DATA

Voltage (International)	115/60/1 (220/50/1)
Total Amps (International)	5.2 (2.6)
10 ft. Cord/Plug [attached] (International)	Yes (No)

SHIPPING DATA

Weight (pounds)	770 (350 kg)
Height - Crated (inches)	45 (1111 mm)
Width - Crated (inches)	96 (2413 mm)
Depth - Crated (inches)	38 (1194 mm)

DRAWER PAN CONFIGURATIONS

Two Tier: (1) 12 x 20 x 6 pan & (3) 1/6 x 6 pans (top)
(2) 12 x 20 x 6 pans (bottom) (supplied by others)



Equipped with one NEMA-5-15P Plug
(varies by country)

* Rating @ +25°F evaporator,
90°F ambient

Figures in parentheses reflect
metric equivalents rounded to the
nearest whole unit

Model Plan Views

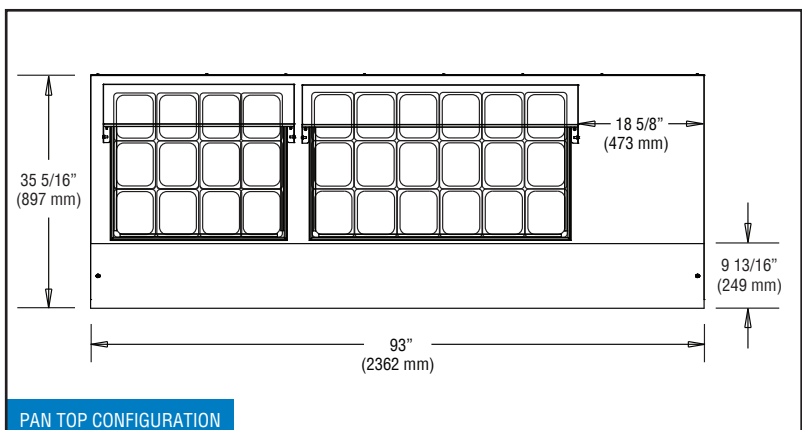
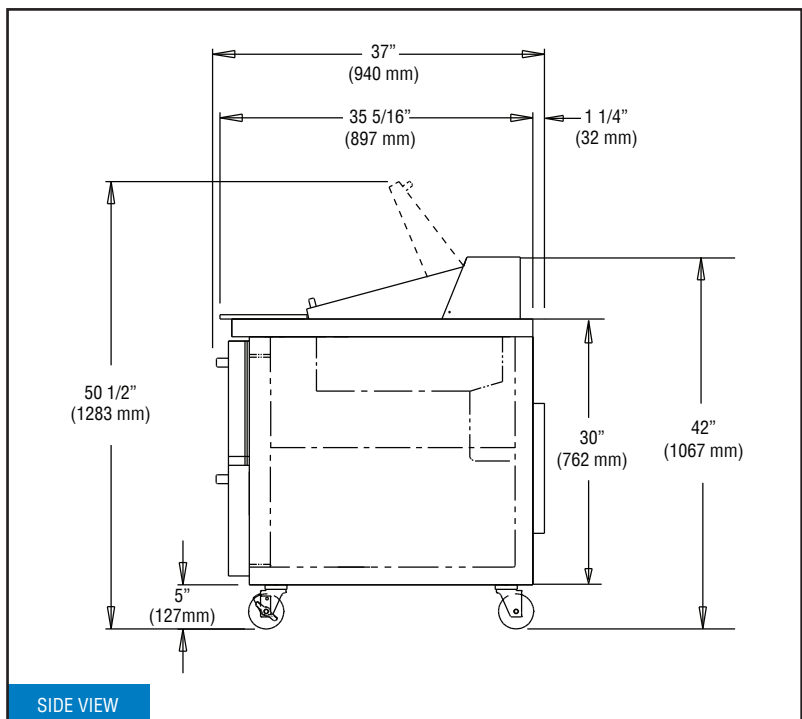
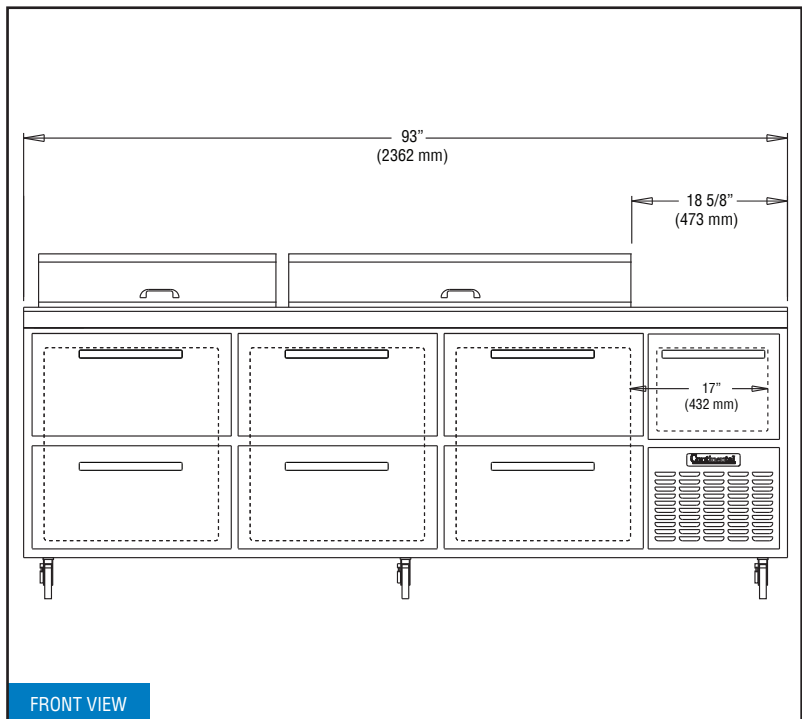

Continental
Refrigerator

Toll-Free: 800-523-7138
Phone: 215-244-1400
Fax: 215-244-9579

539 Dunksferry Road
Bensalem, PA 19020
www.continentalrefrigerator.com

Due to our continued efforts in developing
innovative products, specifications subject
to change without notice.



PROUDLY
DESIGNED & ASSEMBLED
IN THE U.S.A.