



BEVERAGE-AIR®

PROJECT: _____
 ITEM # _____ QTY: _____
 MODEL # _____
 AIA # _____ SIS # _____
 APPROVED: _____

SANDWICH PREP TABLES

Model: SPED72HC-08C-6

SIX DRAWERS WITH 17" CUTTING BOARD

7 YEAR WARRANTY Parts, Labor, and Compressor

CABINET CONSTRUCTION



- Stainless steel front, sides, top, drawers, and grille (galvanized steel back & bottom)
- Interior liner is made of corrosion resistant aluminum
- Removable hoods made of matching stainless steel
- Full electronic control
- Airflow assures that product in open containers is kept below 41°F and above freezing
- (8) 1/6 size 4" deep pans constructed of polycarbonate plastic
- Pans furnished are 4" deep constructed of polycarbonate plastic
- Snap-in magnetic gaskets for positive drawer seal
- Painted aluminum handles
- 17" Wide cutting board constructed of white polyethylene plastic
- Cutting board removable for cleaning
- Stainless steel drawer frames supported on telescoping drawer slides
- Drawer slides include locking mechanism that prevents drawers from being inadvertently pulled off cabinet
- 6" Casters, with (2) brakes standard



OPTIONS & ACCESSORIES

- Stainless steel back
- Stainless steel interior
- Clear lid
- Overshelves (single or double)
- Crumb catcher kit
- Richlite cutting board
- Night cover
- Bottle organizer
- Pan supports
- Pan support crossbar
- Pan configuration
- Locking divider
- 6" Legs or 3" casters
- Low profile casters
- Remote option* (see note on back page)

REFRIGERATION SYSTEM

- Uses environmentally friendly, energy efficient R290 refrigerant, and meets all regulatory requirements for CARB, SNAP, DOE & more
- Adaptive defrost
- Epoxy coated evaporator coil
- Enhanced airflow maintains temperature between 36° to 38°F



BEVERAGE-AIR®

Sandwich Prep Tables Model: SPED72HC-08C-6

PLAN VIEW

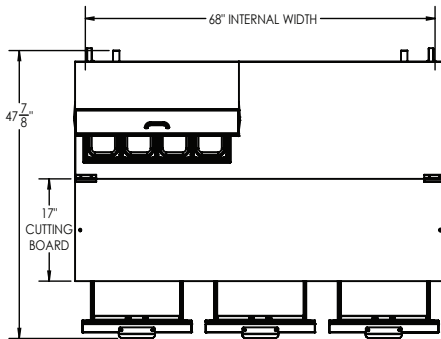

ELEVATION VIEW

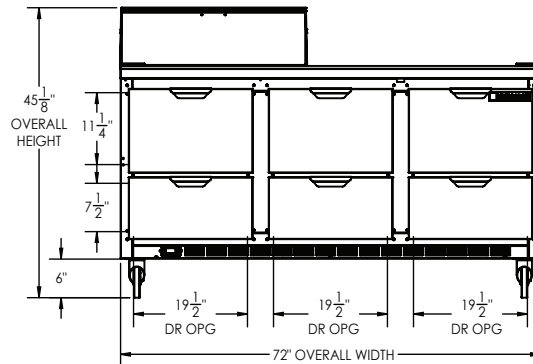

SIDE VIEW

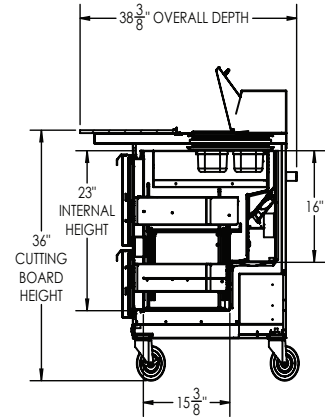

Required Clearance: 3" Bottom & 2" Rear

EXTERNAL DIMENSIONAL DATA

Width Overall (in)	72"
Depth Overall (in)	38 3/8"
Height Overall (in)	45 1/8"
Number of Drawers	6
Depth, Cutting Board	17"
INTERNAL DIMENSIONAL DATA	
NET Capacity (cubic ft.)	20.02
Internal Width Overall (in)	68"
Internal Depth Overall (in)	15 3/8"
Internal Height Overall (in)	23"
Depth with Drawers Open	48 7/8"
Drawers Openings	20 1/2" x 11 1/4" 19 1/2" x 7 1/2"

*NOTE: Remote units are field wired and come with 6" legs. Refrigerant must be specified at time of order.

ELECTRICAL DATA

Full Load Amps	5.4
Voltage	115/60/1
Nema Plug (8' cord)	5-15P

REFRIGERATION DATA

Horsepower	1/3
Capacity (BTU/Hr)	1549
Heat Rejection (BTU/Hr)	2323.5
Charge (lbs/grams/ounces)	0.2095 / 95 / 3.35

SHIPPING DATA

Gross Weight - Crated	456 lbs.
Height - Crated (in)	44"
Width - Crated (in)	74"
Depth - Crated (in)	35"

ELECTRICAL CONNECTION



115/60/1
NEMA 5-15P

Unit pre-wired at factory and include 8' long cord and plug set.

We reserve the right to change specifications and product design without notice. Such revisions do not entitle the buyer to corresponding changes, improvements, additions or replacements for previously purchased equipment. Dimensional tolerances +/- 1/4". Metric dimensions (MM).

3779 Champion Blvd., Winston-Salem, NC 27105 | 888-845-9800 | Fax: 336-245-6453 | Beverage-Air.com | Sales@bevair.com

Date Issued 2/26 | Printed in U.S.A.