



Project _____

Item # _____

Quantity _____

Rapide Cuisine® Drop-In Induction Ranges

Models: IRNG-PB1-14, IRNG-PB1-18

Hatco's patented Rapide Cuisine® Drop-In Professional Induction Range is designed and built for the rigors of commercial foodservice use. Its Magnetic Power System (MPS) delivers the highest power in its class!

This unit can be mounted flush or near flush with the optional trim ring. It has brains and beauty with a high resolution color display, timer, plus convenient power and temperature modes.

Standard features:

- High resolution TFT (thin film transistor) display instantly advises the operator of precise power (1 to 100), temperature (F° or C° in one degree increments) and time control (30 seconds to 10 hours)



- Programmable mode where the operator can create preset programs for consistent cooking cycles and quality product
- Easy to use, color-coded selectable functions
- Adaptive control knob adjusts to user input. From precise, fine control (slow turns) to spanning the full range in a single twist (fast turns)
- Pan Sense Technology (PST) activates the unit only when a suitable pan is placed on top
- Black glass-ceramic top is both durable and easy to clean
- Fully-sealed top with conformal coated boards adds extra protection against grease or moisture
- Safety features and convenience features such as automatic shut-off to prevent overheating
- USB port below the control panel for downloading update
- Includes remote control panel and cord
- 71" (1800 mm) cord with plug



Accessory (available for purchase at any time)

- Trim Ring* in Stainless Steel (holds unit nearly flush on a stainless steel counter [TRIM-PB1-18])

*For use where chair-step routing of the countertop material is not possible, but a flush-mounted look is desired.

For operation, location and safety information, please refer to the Installation and Operating Manual.



HATCO CORPORATION | P.O. Box 340500 Milwaukee, WI 53234-0500 U.S.A. | (414) 671-6350

www.hatcocorp.com | support@hatcocorp.com | [Find a Hatco Rep](#) | [Image Library](#) | [Document Library](#) | [Patents](#) | [Chat](#)



Rapide Cuisine® Drop-In Induction Ranges

Models: IRNG-PB1-14, -18

IRNG-PB1 Model

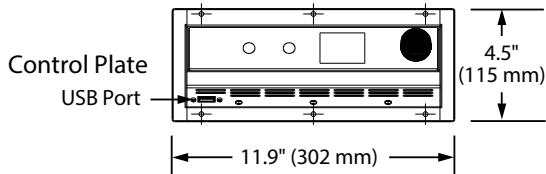
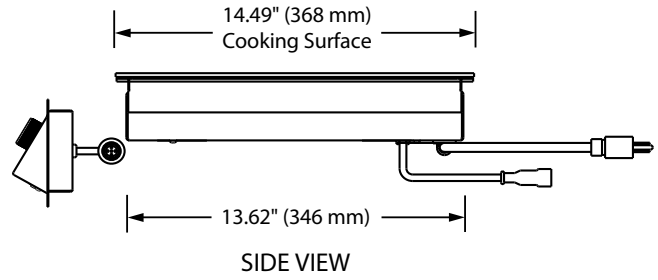
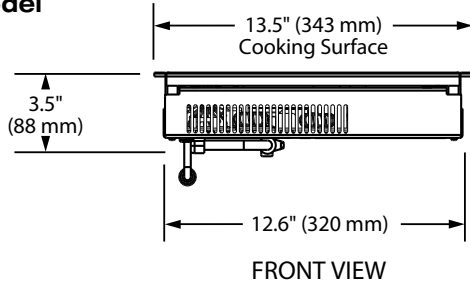

Cutout Dimensions for Control Panel

Model	Width	Height
IRNG-PB1-14, -18	11" (279 mm)	3.5" (89 mm)

IRNG-PB1 Model Cutout Dimensions

Cutout Dimensions for Flush Mount (thicker countertops)

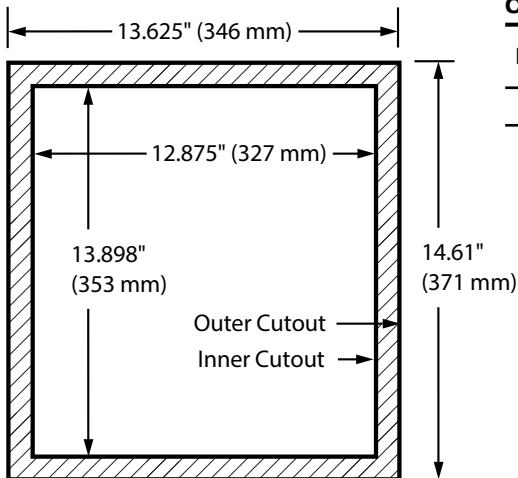

Cutout Dimensions for Flush Mount

Model	Outer Cutout		Inner Cutout	
	Width	Depth	Width	Depth
IRNG-PB1-14, -18	13.625" (346 mm)	14.61" (371 mm)	12.875" (327 mm)	13.898" (353 mm)

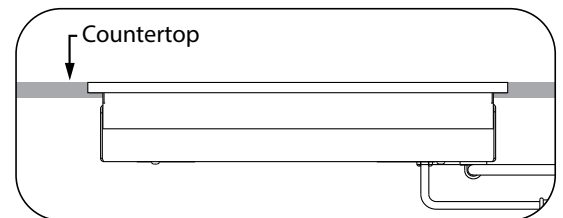
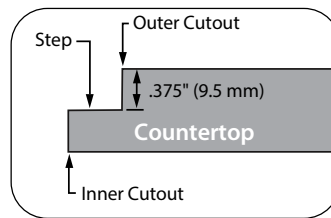

Cutout Dimensions for Trim Ring (holds unit nearly flush on a stainless steel countertop)

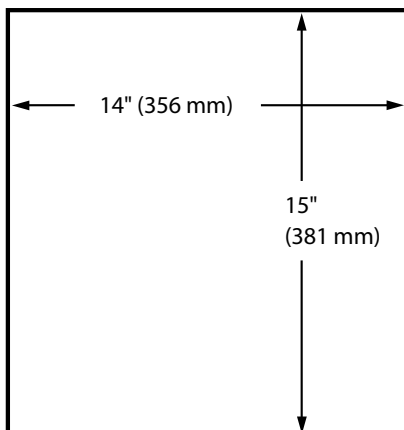

Cutout Dimensions for Trim Ring

Model	Width	Depth
IRNG-PB1-14, -18	14" (356 mm)	15" (381 mm)

Cutaway view of Trim Ring

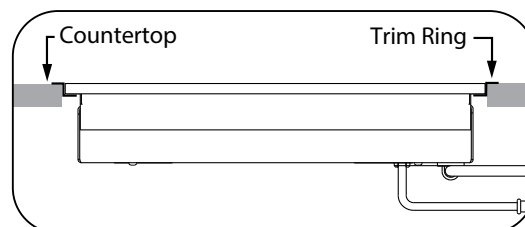

HATCO CORPORATION | P.O. Box 340500 Milwaukee, WI 53234-0500 U.S.A. | (414) 671-6350



www.hatcocorp.com | support@hatcocorp.com | [Find a Hatco Rep](#) | [Image Library](#) | [Document Library](#) | [Patents](#) | [Chat](#)



Rapide Cuisine® Drop-In Induction Ranges

Models: IRNG-PB1-14, -18

IRNG-PB1-14, -18 Model Ventilation Requirements

Clearances: 2" (51 mm) for front and sides.
Minimum 6" (152 mm) for rear.

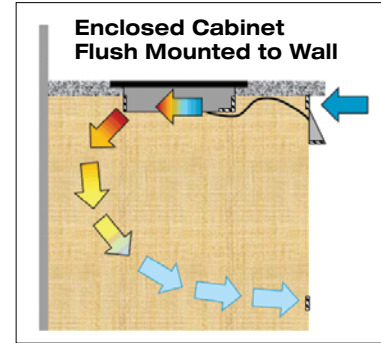
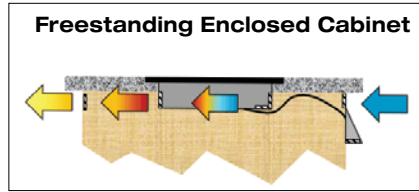

Cabinets should be sufficiently open to allow fresh air to cool the units. Two areas equal to 20 sq. inches (129 sq. cm) each should be provided for each unit. These should be located as close as possible to the intake

(front) and exhaust (rear) sides of the unit. In cases where the cabinet is located against a wall, install one opening near the control panel and the other toward the bottom of the cabinet.

SPECIFICATIONS Drop-In Induction Ranges

Model	Dimensions (Width x Depth x Height)	Volts	Phase	Watts	Hz	Amps	Plug	Cord Location	Approx. Ship Weight
IRNG-PB1-14	13.5" x 14.49" x 3.5" (343 x 368 x 88 mm)	120	Single	1440	50-60	12.0	NEMA 5-15P	Rear left bottom base corner	17 lbs. (8 kg)
IRNG-PB1-18	13.5" x 14.49" x 3.5" (343 x 368 x 88 mm)	120	Single	1800	50-60	15.0	NEMA 5-15P	Rear left bottom base corner	17 lbs. (8 kg)
							NEMA 5-20P*		

*Canadian models use NEMA 5-20P.

PLUG CONFIGURATIONS

PAN SIZE

Maximum Pan Size: 13" diameter (330 mm), Minimum Pan Size: 4" diameter (102 mm)

NEMA 5-15P

NEMA 5-20P



PRODUCT SPECS Rapide Cuisine® Drop-In Induction Ranges

The Drop-In Induction Range shall be a Rapide Cuisine® model, manufactured by the Hatco Corporation, Milwaukee, WI 53234 U.S.A.

The Induction Range shall be rated at ... watts, ... volts, single phase and be ... inches (millimeters) in overall width. The Drop-In Induction Range shall consist of a stainless steel and aluminum housing with a single generator coil, a glass ceramic top surface, food temperature probe and a 71" (1800 mm) cord and plug. It shall include

a remote control box with a glass touch panel, a color-coordinated control (CCC) for 0-100 power steps, temperature (F° or C°) and timer, an infinite control, a USB port (for software updates and operator selected modes) and a 51" (1300 mm) cable. The remote control box is connected to the main case with a quick disconnect connector. Warranty consists of 24/7 parts and service assistance (US and Canada only).

HATCO CORPORATION | P.O. Box 340500 Milwaukee, WI 53234-0500 U.S.A. | (414) 671-6350



www.hatcocorp.com | support@hatcocorp.com | [Find a Hatco Rep](#) | [Image Library](#) | [Document Library](#) | [Patents](#) | [Chat](#)