

# Trail 36 Bar

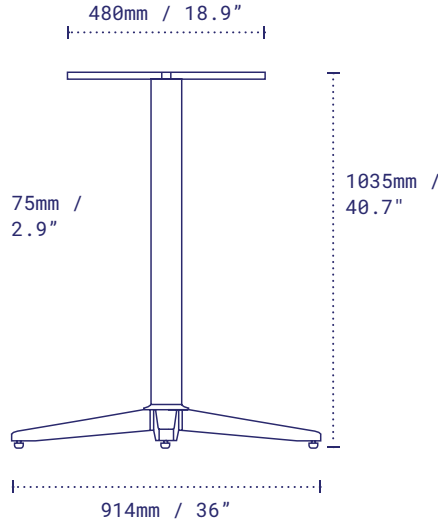



B36NR-BAR : BAR HEIGHT





Trail 36 self-stabilising table base exemplifies modern simplicity. The linear, clean design and concealed componentry complements a robust construction for use in any setting.

Pictured: Trail 36 Bar Height, Sandstone Black.

## DETAILS

 <b>Material</b>	Steel – Zinc Plated Legs, Zinc Phosphate Column
 <b>Next-Level Protection</b>	Steel – Zinc Plated Legs, Zinc Plated Column, Zinc Phosphate Top Plate
 <b>Height</b>	1035mm / 40.7" Bar excl. table top 1080mm / 42.5" Bar (EU only)
 <b>Base diameter</b>	915mm / 36"
 <b>Column width</b>	75mm / 2.9"
 <b>Top plate</b>	Fixed
 <b>Net weight</b>	12.2kg / 26.8lbs
 <b>Max recommended table top</b>	○ 1066mm / 42" □ 965mm / 38"
 <b>Resources</b>	<a href="https://no-rock.com/product/trail">no-rock.com/product/trail</a>

## PACKAGING

 <b>Carton</b>	680 x 680 x 100mm / 26.7 x 26.7 x 3.9" x Box 1 83 x 84 x 1020mm / 3.2 x 3.3 x 40.1" x Box 2
 <b>Gross weight</b>	14.7kg / 32.4lbs

## STANDARD COLOR RANGE

● Sandstone Black

