



K-105 14" SWING SPOUT SPLASH MOUNT FAUCET

Conforms To NSF 61/9 Lead Free Requirements



**FAUCET AERATOR CONFORM TO
ASTM.A112.18.1M
2.2 GPM/8.3 LPM
THREAD: 55/64 - 27 FEMALE**

Item #: _____ Qty #: _____

Model #: _____

Project #: _____

FEATURES:

- 14" swing spout.
- 8" O.C. water supply.
- Quarter-turn wedge style handles.
- Colored hot & cold indexes.
- 2.2 GPM/8.3 LPM Aerator. 60 PSI.

MATERIAL:

- Brass chrome plated body & spout.
- Chrome plated handles.



**Click This Link To
View Assembly Sheet**

DIMENSIONS and SPECIFICATIONS

Options & Accessories



**14" Replacement
Swing Spout
K-105SP**



**Replacement Cartridges
K-07 (Set)**



**Faucet Mounting Kit
K-06**



**Wrist Handles
K-416-LU (Set)**

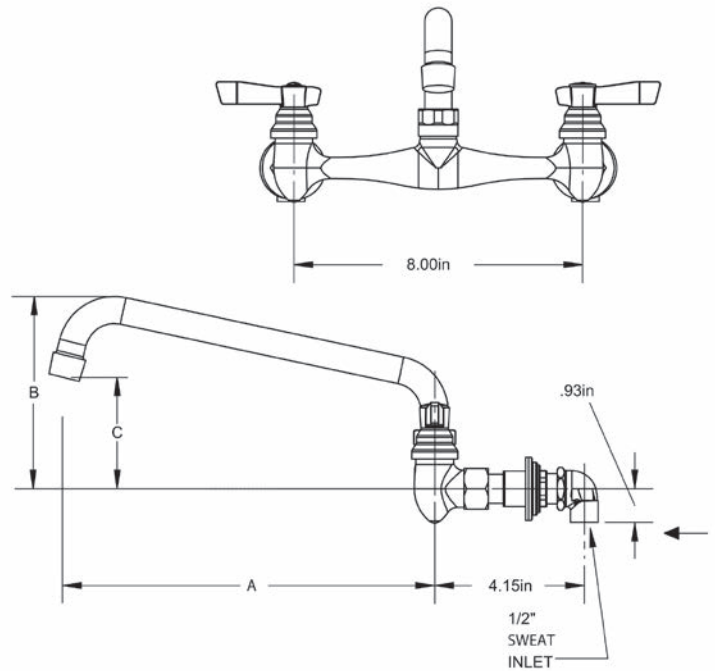

A	B	C	On Center Dimensions
14.11"	6.14"	3.89"	8" O.C.

WARNING: Faucets on this page may expose you to chemicals, including lead, that are known to the State of California to cause cancer or birth defects or other reproductive harm. For more info., visit www.p65warnings.ca.gov.



Customer Service Available To Assist You 1-800-645-3166 8:30 am - 7:00 pm E.S.T.

For Orders & Customer Service:

Email: customer@advancetabco.com or Fax: 631-242-6900

For Smart Fabrication™ Quotes:

Email: smartfab@advancetabco.com or Fax: 631-586-2933