



Serving the Food Industry Since 1951



VINOVERO WINE COOLERS

ITEM: 47149	48258	48259	48260	48261
48525	45258	45259	45260	45261

23.5" Wide



48260
40 Bottle
Dual Zone



45260
40 Bottle
Dual Zone



48261
51 Bottle
Single Zone



45261
51 Bottle
Single Zone

31.5" Wide



48525
126 Bottle
Dual Zone



48526
126 Bottle
Dual Zone



48258
180 Bottle
Dual Zone



45258
180 Bottle
Dual Zone



48259
192 Bottle
Single Zone



45259
192 Bottle
Single Zone



47149
290 Bottle
Dual Zone

Telephone: 1-800-465-0234

Fax: (905) 607-0234

Email: sales@omcan.com

Website: www.omcan.com



Authorized Dealer

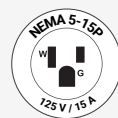

Made in China

48260
40 Bottle
Dual Zone



45260
40 Bottle
Dual Zone



48261
51 Bottle
Single Zone



45261
51 Bottle
Single Zone



Item no.	48260	45260	48261	45261
Model	WC-CN-0040-DB	WC-CN-0040-D	WC-CN-0051-SB	WC-CN-0051-S
Door Type	Black Glass Door	Stainless Steel Door	Black Glass Door	Stainless Steel Door
Zone	Dual Zones	Dual Zones	Single Zone	Single Zone
Capacity	40 Bottles	40 Bottles	51 Bottles	51 Bottles
Electricals	115 V / 60 Hz / 1	115 V / 60 Hz / 1	115 V / 60 Hz / 1	115 V / 60 Hz / 1
Power	103W/ 0.10kW	103W/ 0.10kW	103W/ 0.10kW	103W/ 0.10kW
Inner Humidity	40-60%	40-60%	40-60%	40-60%
Max Ambient Range	24 °C (75 °F)	24 °C (75 °F)	24 °C (75 °F)	24 °C (75 °F)
Temperature Range	3 - 22 °C (37.4-71.6 °F)	3 - 22 °C (37.4-71.6 °F)	3 - 22 °C (37.4-71.6 °F)	3 - 22 °C (37.4-71.6 °F)
Refrigerant	R600a	R600a	R600a	R600a
Net Weight	98 lbs. (44.5 kg.)	98 lbs. (44.5 kg.)	98 lbs. (44.5 kg.)	98 lbs. (44.5 kg.)
Net Dimensions (WDH)	23.4 x 22.8 x 32.3 in. (595 x 580 x 820 mm.)	23.4 x 22.8 x 32.3 in. (595 x 580 x 820 mm.)	23.4 x 22.8 x 32.3 in. (595 x 580 x 820 mm.)	23.4 x 22.8 x 32.3 in. (595 x 580 x 820 mm.)
Door Lock	Yes	Yes	Yes	Yes

*Dimensions rounded up to the nearest tenth inch or millimeter.
Specifications subject to change without notice.*

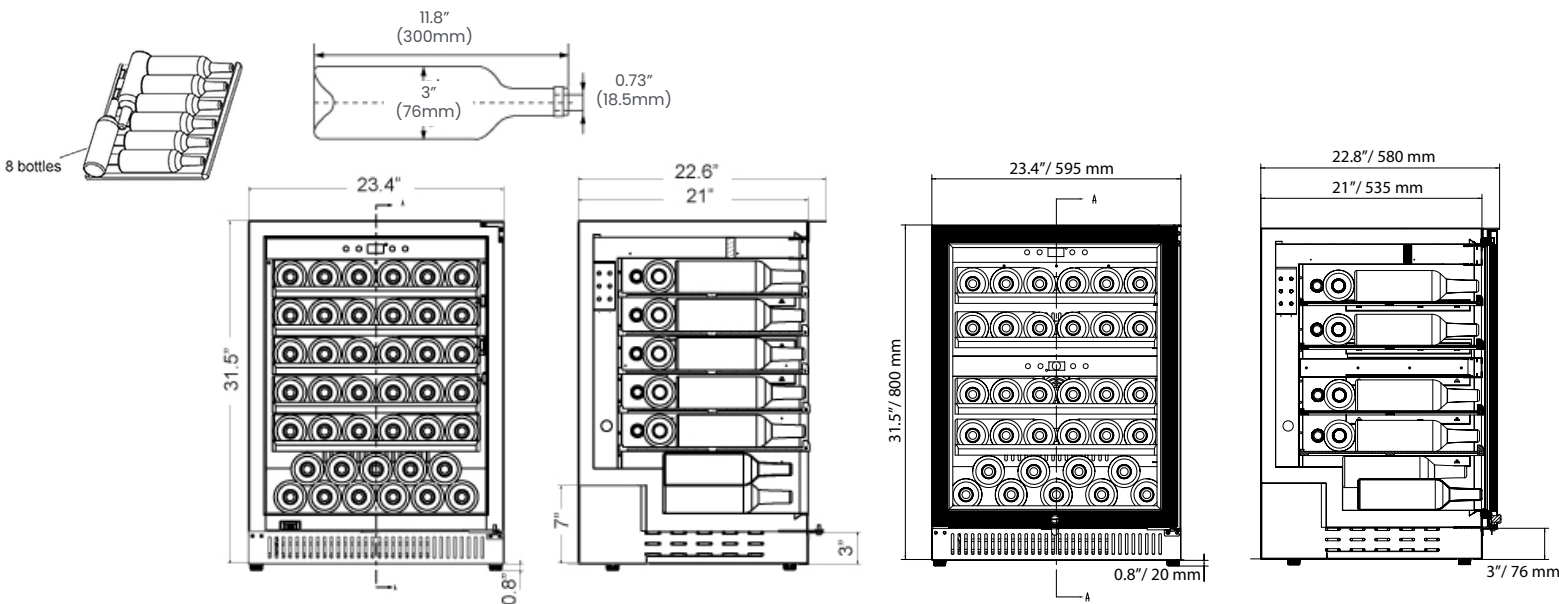



48525
126 Bottle
Dual Zone



48526
126 Bottle
Dual Zone



48258
180 Bottle
Dual Zone



45258
180 Bottle
Dual Zone



48259
192 Bottle
Single Zone



45259
192 Bottle
Single Zone

Item no.	48525	48526	48258	45258	48259	45259
Model	WC-CN-0126-DB	WC-CN-0126-D	WC-CN-0181-DB	WC-CN-0181-D	WC-CN-0192-SB	WC-CN-0192-S
Door Type	Black Glass Door	Stainless Steel Door	Black Glass Door	Stainless Steel Door	Black Glass Door	Stainless Steel Door
Zone	Dual Zones	Dual Zones	Dual Zones	Dual Zones	Single Zone	Single Zone
Capacity	126 Bottles	126 Bottles	180 Bottles	180 Bottles	192 Bottles	192 Bottles
Electricals	115 V / 60 Hz / 1	115 V / 60 Hz / 1	115 V / 60 Hz / 1	115 V / 60 Hz / 1	115 V / 60 Hz / 1	115 V / 60 Hz / 1
Power	160W/ 0.16kW	160W/ 0.16kW	160W/ 0.16kW	160W/ 0.16kW	160W/ 0.16kW	160W/ 0.16kW
Inner Humidity	50-80%	50-80%	40-60%	40-60%	40-60%	40-60%
Ambient Range	16 - 38 °C (60-100 °F)	16 - 38 °C (60-100 °F)	16 - 38 °C (60-100 °F)	16 - 38 °C (60-100 °F)	16 - 38 °C (60-100 °F)	16 - 38 °C (60-100 °F)
Temperature Range	5 - 20 °C (41-68 °F)	5 - 20 °C (41-68 °F)	5 - 20 °C (41-68 °F)	5 - 20 °C (41-68 °F)	5 - 20 °C (41-68 °F)	5 - 20 °C (41-68 °F)
Refrigerant	R600a	R600a	R600a	R600a	R600a	R600a
Net Weight	174.2 lb (79 kg)	174.2 lb (79 kg)	224.7 lbs (101.9 kg)	224.7 lb (101.9 kg)	228 lbs (103.4 kg)	228 lbs (103.4 kg)
Net Dimensions (WDH)	23.4 x 24.5 x 62.7" (595 x 621 x 1592 mm)	23.4 x 24.5 x 62.7" (595 x 621 x 1592 mm)	23.4 x 26.6 x 73" (595 x 675 x 1854 mm)	23.4 x 26.6 x 73" (595 x 675 x 1854 mm)	23.4 x 26.6 x 73" (595 x 675 x 1854 mm)	23.4 x 26.6 x 73" (595 x 675 x 1854 mm)
Door Lock	Yes	Yes	Yes	Yes	Yes	Yes

Dimensions rounded up to the nearest tenth inch or millimeter.
Specifications subject to change without notice.
Tech drawings on next page.

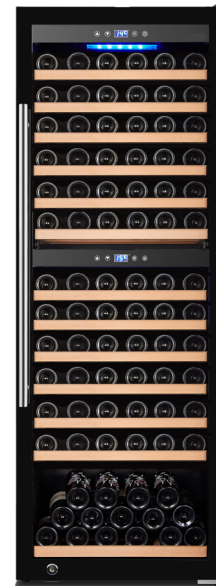
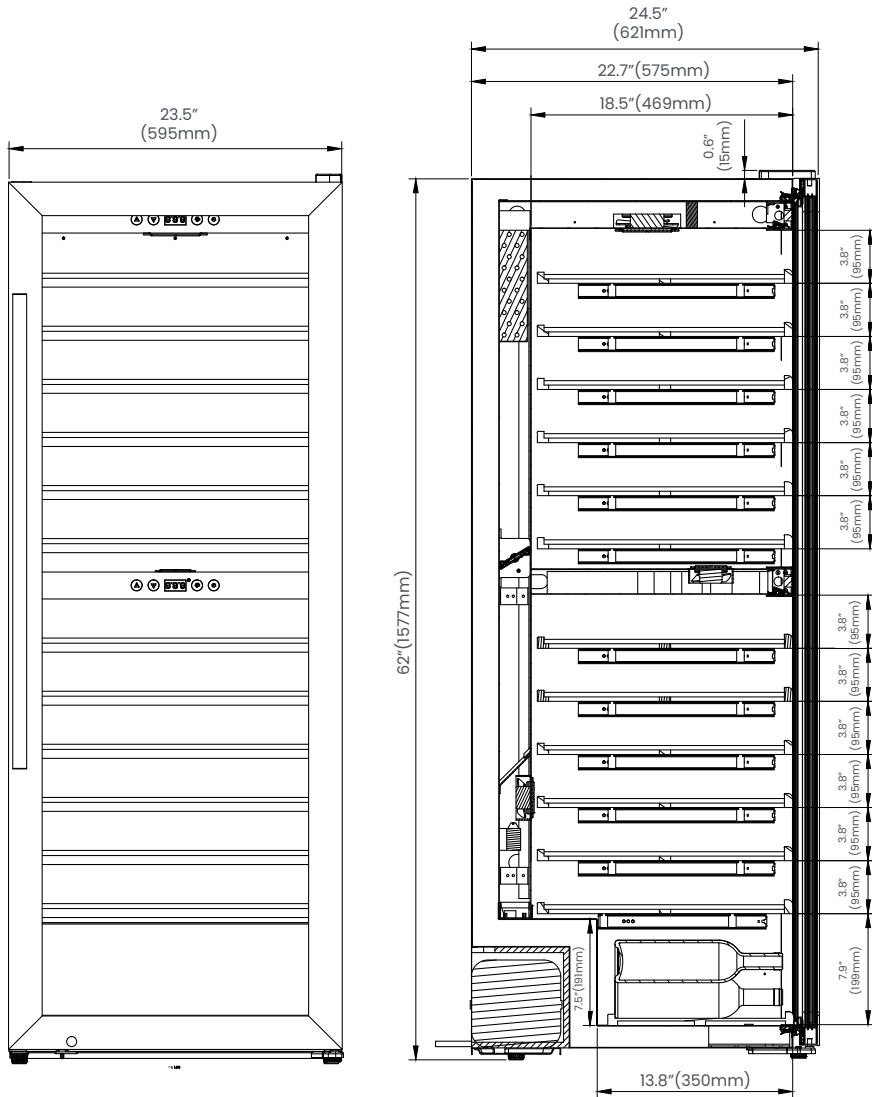

48525
126 Bottle
Dual Zone



48526
126 Bottle
Dual Zone

Item no.	48525	48526
Model	WC-CN-0126-DB	WC-CN-0126-D
Door Type	Black Glass Door	Stainless Steel Door
Zone	Dual Zones	Dual Zones
Capacity	126 Bottles	126 Bottles
Electricals	115 V / 60 Hz / 1	115 V / 60 Hz / 1
Power	160W/ 0.16kW	160W/ 0.16kW
Inner Humidity	50-80%	50-80%
Ambient Range	16 - 38 °C (60-100 °F)	16 - 38 °C (60-100 °F)
Temperature Range	5 - 20 °C (41-68 °F)	5 - 20 °C (41-68 °F)
Refrigerant	R600a	R600a
Net Weight	174.2 lb (79 kg)	174.2 lb (79 kg)
Net Dimensions (WDH)	23.4 x 24.5 x 62.7" (595 x 621 x 1592 mm)	23.4 x 24.5 x 62.7" (595 x 621 x 1592 mm)
Door Lock	Yes	Yes

Dimensions rounded up to the nearest tenth inch or millimeter. Specifications subject to change without notice.

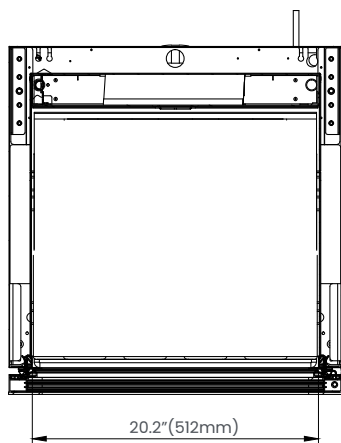

Item no.	48258	45258	48259	45259
Model	WC-CN-0181-DB	WC-CN-0181-D	WC-CN-0192-SB	WC-CN-0192-S
Door Type	Black Glass Door	Stainless Steel Door	Black Glass Door	Stainless Steel Door
Zone	Dual Zones	Dual Zones	Single Zone	Single Zone
Capacity	180 Bottles	180 Bottles	192 Bottles	192 Bottles
Electricals	115 V / 60 Hz / 1	115 V / 60 Hz / 1	115 V / 60 Hz / 1	115 V / 60 Hz / 1
Power	160W/ 0.16kW	160W/ 0.16kW	160W/ 0.16kW	160W/ 0.16kW
Inner Humidity	40-60%	40-60%	40-60%	40-60%
Ambient Range	16 - 38 °C (60-100 °F)	16 - 38 °C (60-100 °F)	16 - 38 °C (60-100 °F)	16 - 38 °C (60-100 °F)
Temperature Range	5 - 20 °C (41-68 °F)	5 - 20 °C (41-68 °F)	5 - 20 °C (41-68 °F)	5 - 20 °C (41-68 °F)
Refrigerant	R600a	R600a	R600a	R600a
Net Weight	224.7 lbs (101.9 kg)	224.7 lb (101.9 kg)	228 lbs (103.4 kg)	228 lbs (103.4 kg)
Net Dimensions (WDH)	23.4 x 26.6 x 73" (595 x 675 x 1854 mm)	23.4 x 26.6 x 73" (595 x 675 x 1854 mm)	23.4 x 26.6 x 73" (595 x 675 x 1854 mm)	23.4 x 26.6 x 73" (595 x 675 x 1854 mm)
Door Lock	Yes	Yes	Yes	Yes

11 bottles

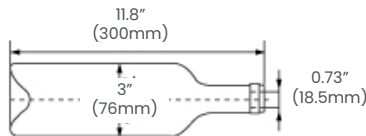
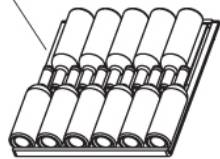

*Dimensions rounded up to the nearest tenth inch or millimeter.
Specifications subject to change without notice.*

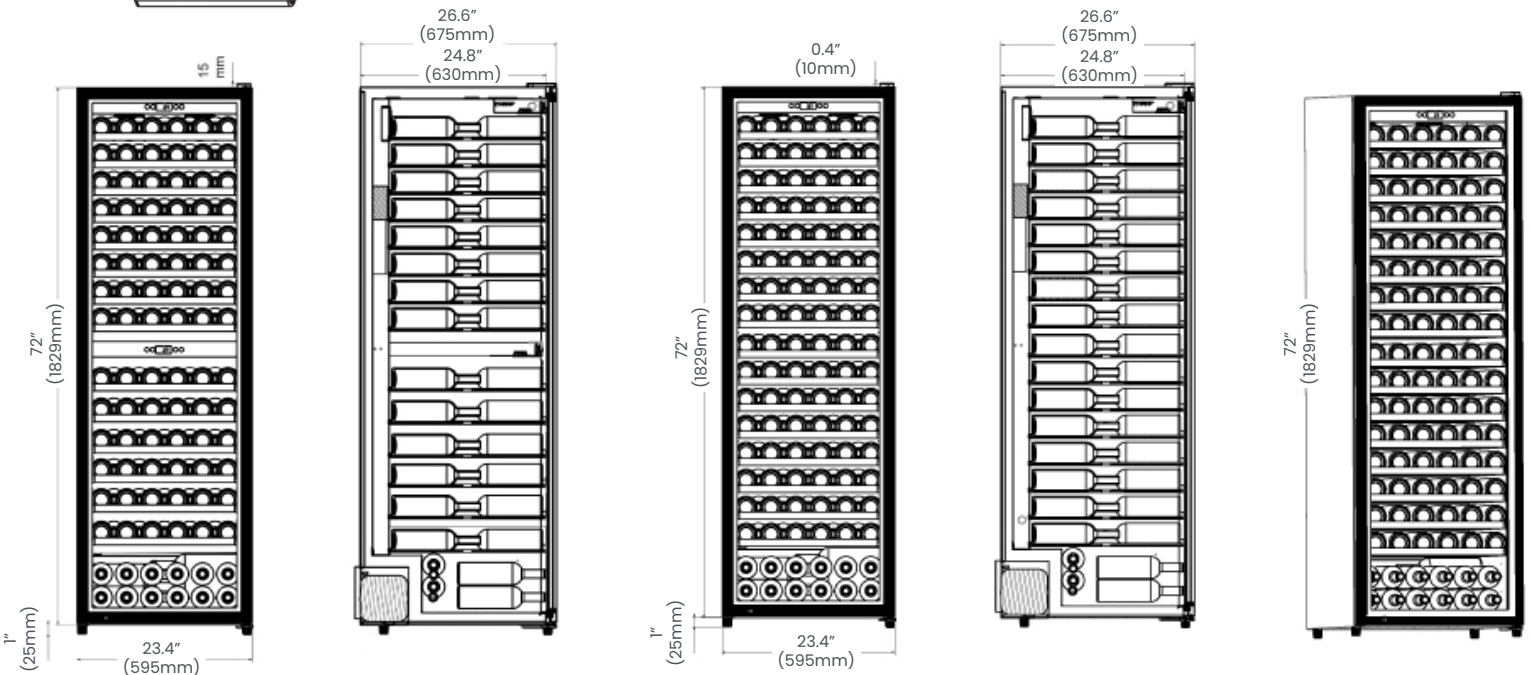

31.5" Dual Zone Wine Cooler 290 Btl.

Item	47149
Model	WC-CN-0275-D
Door Type	Black Glass Door
Zone	Dual Zones
Capacity	290 Bottles
Electricals	115 V / 60 Hz / 1
Power	230W/ 0.23kW
Inner Humidity	60-70%
Max Ambient Range	16 - 38 °C (60-100 °F)
Temperature Range	5 - 20 °C (41-68 °F)
Refrigerant	R600a
Net Weight	317.5 lbs. (144 kg.)
Net Dimensions (WDH)	31.5 x 28.3 x 81.3 in. (800 x 716 x 2067 mm.)
Door Lock	Yes



47149
290 Bottle
Dual Zone

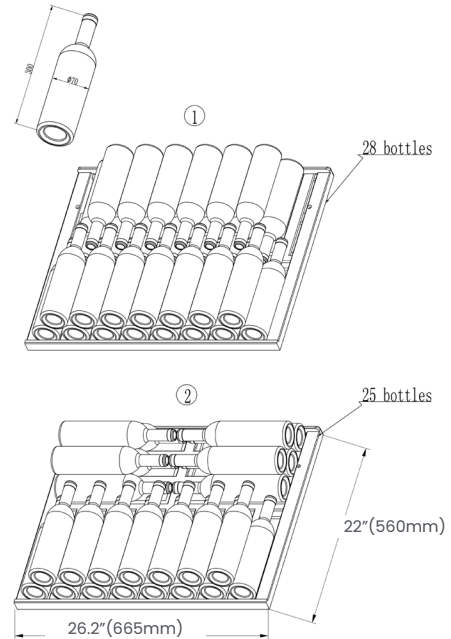
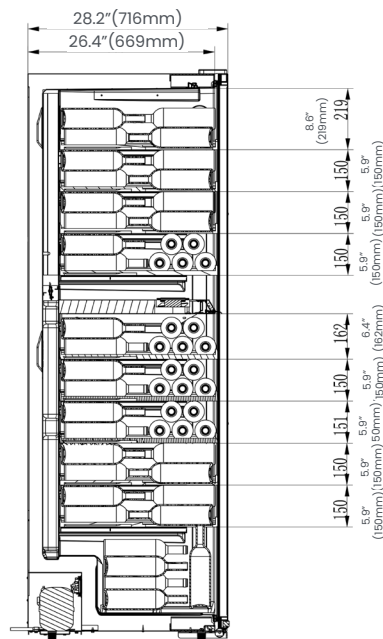
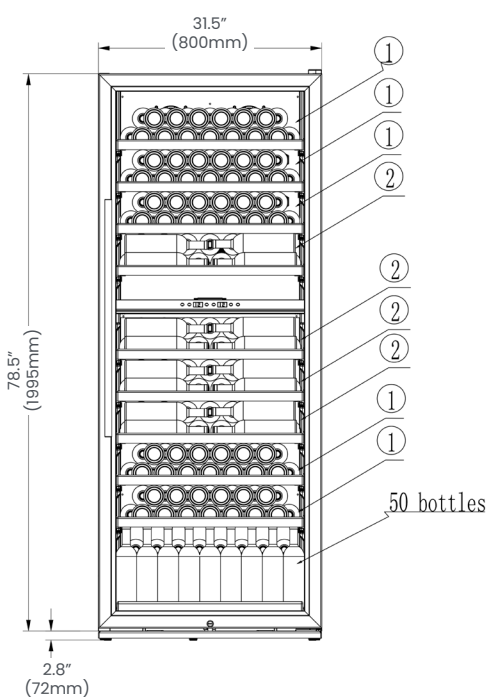

Dimensions rounded up to the nearest tenth inch or millimeter.
Specifications subject to change without notice.